



# KT-LED20HID-E26-850-D

## HID REPLACEMENT LED LAMP

### DESCRIPTION

20W HID Replacement LED Lamp | 5000K | >83 CRI | IP64 Rated



<b>LAMP TYPE:</b> HID Replacement LED
<b>BASE TYPE:</b> E26 (Medium)
<b>WATTAGE:</b> 20W
<b>COLOR TEMPERATURE:</b> 5000K
<b>METAL HALIDE EQUIVALENT:</b> 50-70W
<b>COLOR RENDERING INDEX (CRI):</b> >83
<b>WARRANTY:</b> 5 Years



### PRODUCT FEATURES

- Replacement for Conventional Metal Halide Lamp
- Non-Dimmable; Do Not Dim
- 50,000+ Hour Lifetime
- Environmentally Friendly: No Mercury Used
- Instant Startup
- UL Listed
- Operating Temperature: -29°C/-20°F to 60°C/140°F
- Integral Driver, Eliminates the Need for External Driver or Ballast; Includes 4kV Surge Protection
- IP64 Rated; Integrated Heat Sink Quickly Dissipates Heat and Guides Water Intrusion Out of the Lamp
- Suitable for Use in Fully Enclosed Fixture

### OPERATING SPECIFICATIONS

#### ELECTRICAL CHARACTERISTICS

Input Voltage	Power Consumption	Power Factor	Input Current
120-277Vac	20W	>0.9	0.21A @ 120V 0.09A @ 277V

#### RATED LIFE

L70 (Hours)	50,000
-------------	--------

#### PHOTOMETRIC CHARACTERISTICS

Color Temperature (CCT)	5000K
Luminous Flux	2130 lm
Color Rendering Index (CRI)	>83
Efficacy	107 lm/W
Visible Light Area	360°

#### SPECTRAL DISTRIBUTION

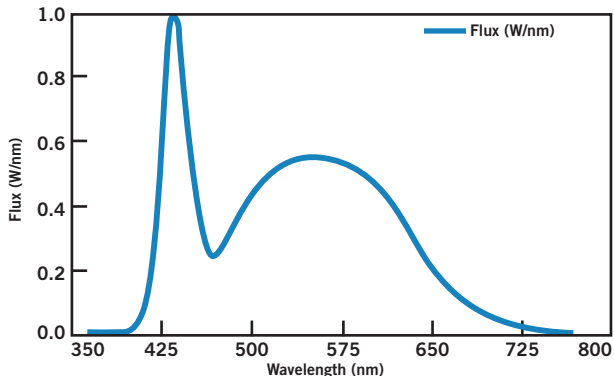

#### LUX DISTANCE CURVE

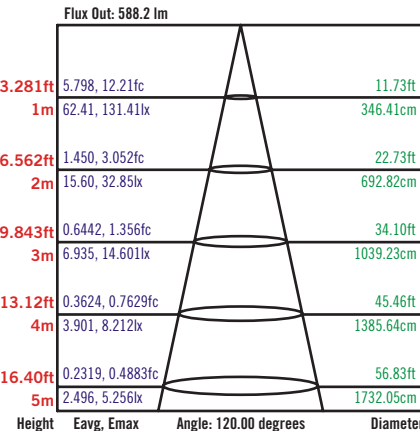

Note: The curves indicate the illuminated area and the average illumination when the luminaire is at a different distance.



# KT-LED20HID-E26-850-D

## HID REPLACEMENT LED LAMP

### WIRING DIAGRAM

- STEP 1**  
**Disconnect power.** Disconnect and remove existing ballast, capacitor, and/or ignitor (where applicable) from fixture.
- STEP 2**  
Rewire for line voltage to the lamp socket.
- STEP 3**  
Install new LED replacement lamp. Ensure lamp is operating properly when power is turned on.

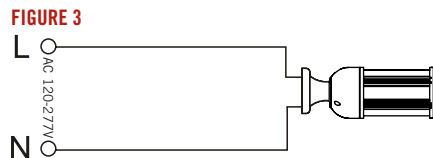
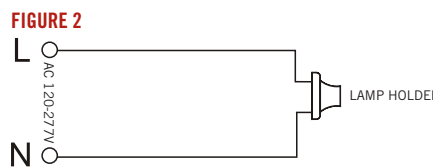
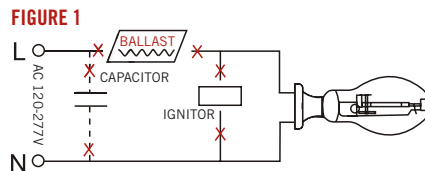
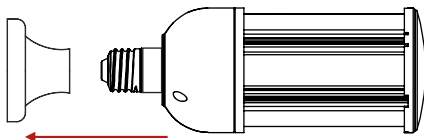

### PHYSICAL CHARACTERISTICS

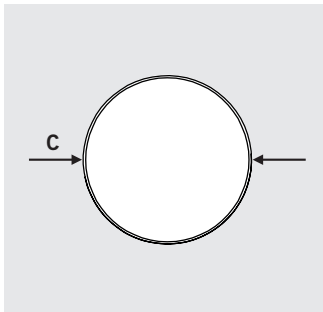
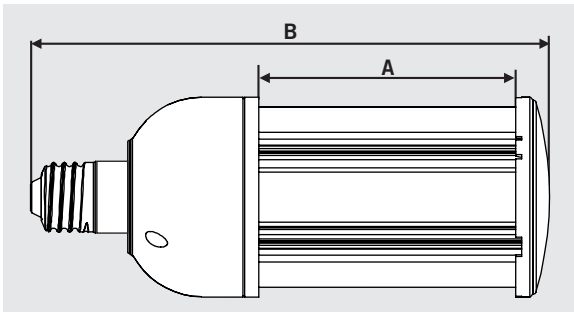

#### LAMP DIMENSIONS

A (Illuminated Length)	4.17"
B (Body Length)	7.52"
C (Diameter)	2.76"

**BASE TYPE:** E26 (Medium)

### ORDERING INFORMATION

ORDER CODE	PACKAGING STYLE	PACK QTY.	ITEM STATUS
KT-LED20HID-E26-850-D-DP	Distributor Pack (Individual Cartons)	12	Quick Ship

### CATALOG NUMBER BREAKDOWN

KT-LED20HID-E26-850-D-DP

Keystone Technologies	LED Lamp	Wattage	Lamp Type	Base Type	800 Series	Color Temp.	Direct Drive Series	Packaging Style
-----------------------	----------	---------	-----------	-----------	------------	-------------	---------------------	-----------------