



# KT-LED45HID-H-EX39-830-D

## HID REPLACEMENT LED LAMP

### DESCRIPTION

45W HID Replacement LED Lamp | 3000K | 85 CRI | IP64 Rated



<b>LAMP TYPE:</b> HID Replacement LED
<b>BASE TYPE:</b> EX39 (Mogul) Rotatable
<b>WATTAGE:</b> 45W
<b>COLOR TEMPERATURE:</b> 3000K
<b>METAL HALIDE EQUIVALENT:</b> 175W
<b>COLOR RENDERING INDEX (CRI):</b> 85
<b>WARRANTY:</b> 5 Years

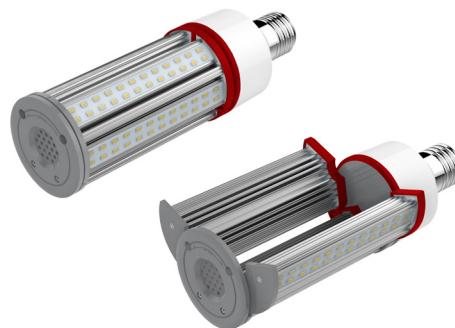

### PRODUCT FEATURES

- Replacement for Conventional Metal Halide Lamp
- Ideal for Wallpack Retrofit Applications
- Optimized for Horizontal Applications with Directional Light Output from Opening LED Assembly Construction
- Non-Dimmable; Do Not Dim
- 50,000+ Hour Lifetime
- Environmentally Friendly: No Mercury Used
- Instant Startup
- UL Listed
- Operating Temperature: -40°C/-40°F to 45°C/113°F in Enclosed Fixture
- Integral Driver, Eliminates the Need for External Driver or Ballast; Includes 4kV Surge Protection
- IP64 Rated; Integrated Heat Sink Quickly Dissipates Heat and Guides Water Intrusion Out of the Lamp
- Horizontal Orientation
- Suitable for Use in Fully Enclosed Fixture

### OPERATING SPECIFICATIONS

#### ELECTRICAL CHARACTERISTICS

Input Voltage	Power Consumption	Power Factor	Input Current
120-277Vac	45W	>0.9	0.38A @ 120V 0.16A @ 277V

#### PHOTOMETRIC CHARACTERISTICS

Color Temperature (CCT)	3000K
Luminous Flux	6200 lm
Color Rendering Index (CRI)	85
Efficacy	138 lm/W
Beam Angle	180°

#### RATED LIFE

L70 (Hours)	50,000
-------------	--------

#### SPECTRAL DISTRIBUTION

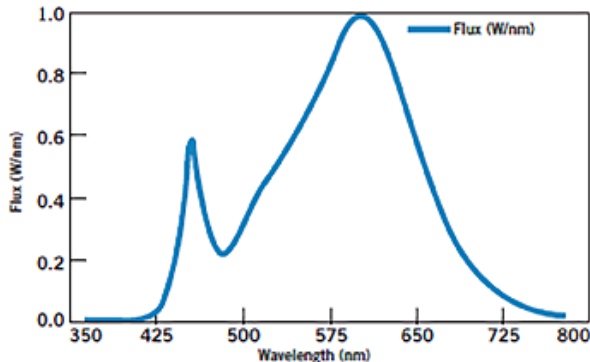

#### LUX DISTANCE CURVE

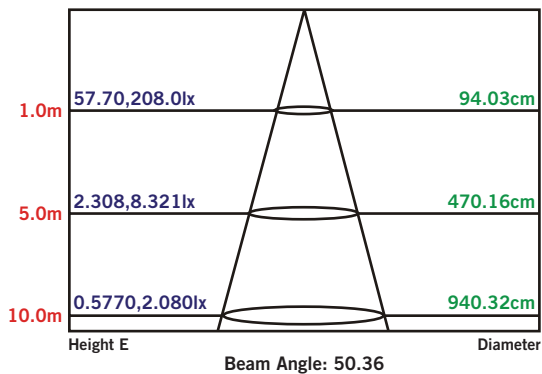



# KT-LED45HID-H-EX39-830-D

## HID REPLACEMENT LED LAMP

### WIRING INSTRUCTIONS

**STEP 1**

**Disconnect power.** Disconnect and remove existing ballast, capacitor, and/or ignitor (where applicable) from fixture.

**STEP 2**

Rewire for line voltage to the lamp socket.

**STEP 3**

Install new LED replacement lamp. Ensure lamp is operating properly when power is turned on.

**STEP 4**

Rotate lamp base and open wings accordingly toward direction of desired lumination.

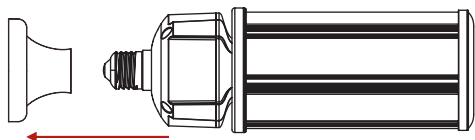

**STEP 1**

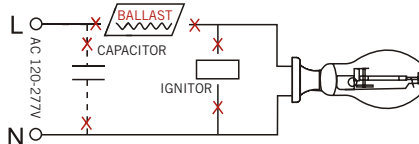

**STEP 2**

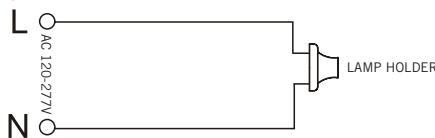

**STEP 3**

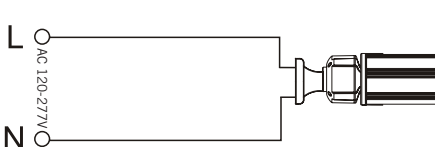

**STEP 4**

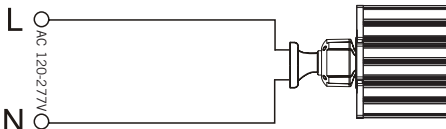

### PHYSICAL CHARACTERISTICS

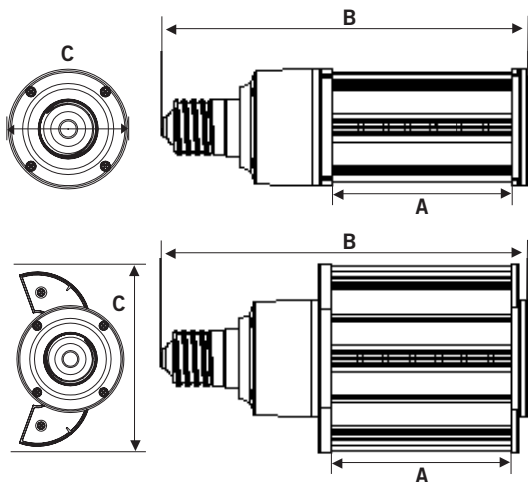

#### LAMP DIMENSIONS

**WINGS CLOSED**

A (Illuminated Length)	5.83"
B (Body Length)	10.23"
C (Width)	3.23"

**WINGS OPEN**

A (Illuminated Length)	5.83"
B (Body Length)	10.23"
C (Width)	5.26"

**BASE TYPE:** EX39 (Mogul) Rotatable



# KT-LED45HID-H-EX39-830-D

## HID REPLACEMENT LED LAMP

### ORDERING INFORMATION

ORDER CODE	PACKAGING STYLE	PACK QTY.	ITEM STATUS
KT-LED45HID-H-EX39-830-D-DP	Distributor Pack (Individual Cartons)	16	Quick Ship

### CATALOG NUMBER BREAKDOWN

