



# KT-LED27HID-H-E26-840-D

## HID REPLACEMENT LED LAMP

### DESCRIPTION

27W HID Replacement LED Lamp | 4000K | 85 CRI | IP64 Rated



<b>LAMP TYPE:</b> HID Replacement LED
<b>BASE TYPE:</b> E26 (Medium) Rotatable
<b>WATTAGE:</b> 27W
<b>COLOR TEMPERATURE:</b> 4000K
<b>METAL HALIDE EQUIVALENT:</b> 100W
<b>COLOR RENDERING INDEX (CRI):</b> 85
<b>WARRANTY:</b> 5 Years

### PRODUCT FEATURES

- Replacement for conventional metal halide lamp
- Ideal for wallpack retrofit applications
- Optimized for horizontal applications with directional light output from opening LED assembly construction
- Non-dimmable; do not dim
- 50,000+ hour lifetime
- Environmentally friendly: No mercury used
- Instant startup
- UL Listed; Listed on DLC QPL
- Operating temperature: -40°C/-40°F to 45°C/113°F in enclosed fixture
- Integral driver, eliminates the need for external driver or ballast; includes 4kV surge protection
- IP64 Rated; integrated heat sink quickly dissipates heat and guides water intrusion out of the lamp
- Horizontal orientation
- Suitable for use in fully enclosed fixture

### OPERATING SPECIFICATIONS

#### ELECTRICAL CHARACTERISTICS

Input Voltage	Power Consumption	Power Factor	Input Current
120-277Vac	27W	>0.9	0.23A @ 120V 0.10A @ 277V

#### PHOTOMETRIC CHARACTERISTICS

Color Temperature (CCT)	4000K
Luminous Flux	4000 lm
Color Rendering Index (CRI)	85
Efficacy	148 lm/W
Beam Angle	180°

#### RATED LIFE

L70 (Hours)	50,000
-------------	--------

#### SPECTRAL DISTRIBUTION

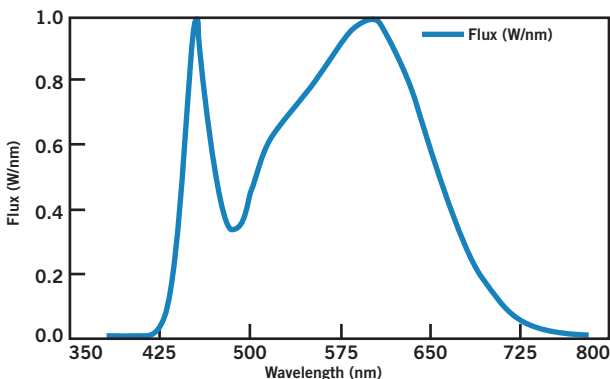

#### LUX DISTANCE CURVE

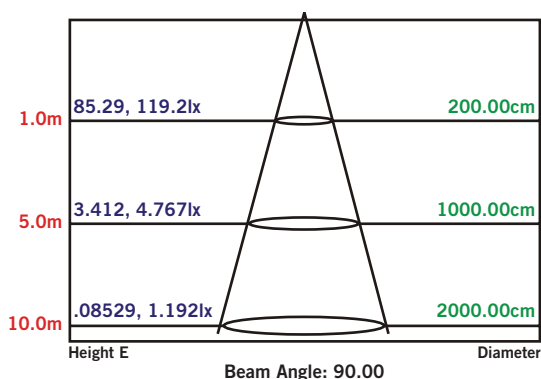



# KT-LED27HID-H-E26-840-D

## HID REPLACEMENT LED LAMP

### WIRING INSTRUCTIONS

**STEP 1**

**Disconnect power.** Disconnect and remove existing ballast, capacitor, and/or ignitor (where applicable) from fixture.

**STEP 2**

Rewire for line voltage to the lamp socket.

**STEP 3**

Install new LED replacement lamp. Ensure lamp is operating properly when power is turned on.

**STEP 4**

Rotate lamp base and open wings accordingly toward direction of desired lumination.

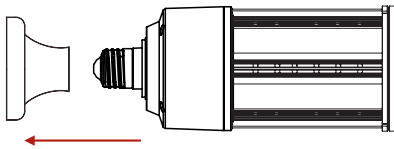
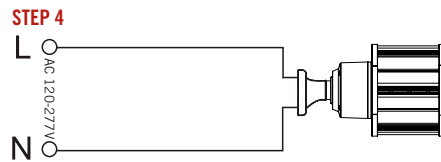
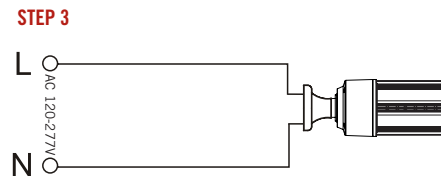
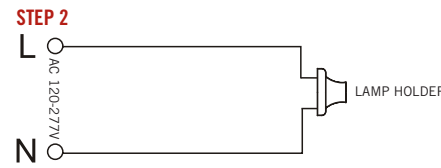
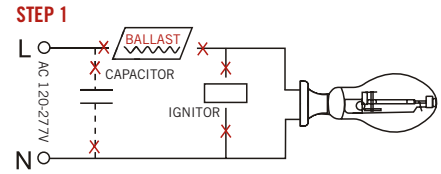

### PHYSICAL CHARACTERISTICS

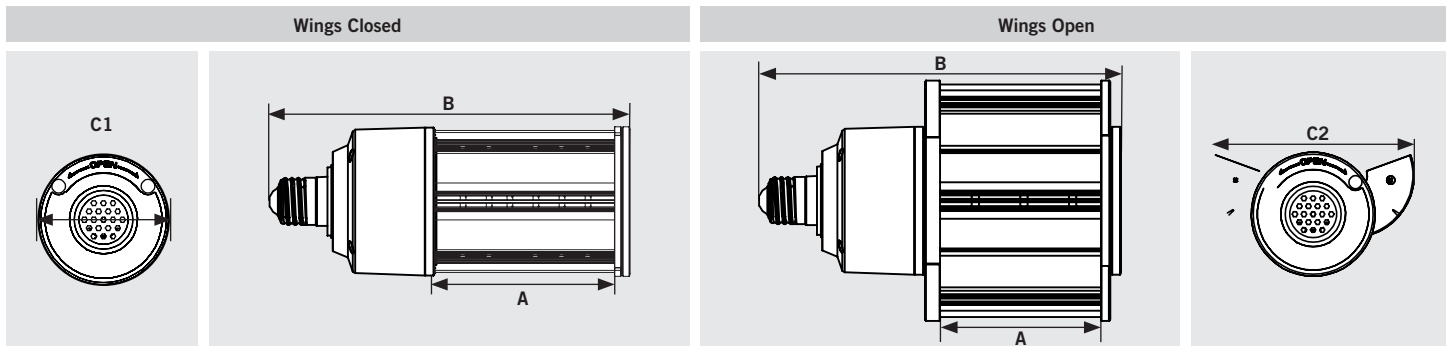

**LAMP DIMENSIONS**

<b>A (Illuminated Length)</b>	3.62"	<b>C (Diameter)</b>	3.23"
<b>B (Body Length)</b>	8.10"	<b>C2 (Width, Wings Open)</b>	5.26"

**BASE TYPE:** E26 (Medium) Rotatable



# KT-LED27HID-H-E26-840-D

HID REPLACEMENT LED LAMP

## ORDERING INFORMATION

ORDER CODE	PACKAGING STYLE	PACK QTY.	ITEM STATUS
KT-LED27HID-H-E26-840-D-DP	Distributor Pack (Individual Cartons)	16	Quick Ship

## CATALOG NUMBER BREAKDOWN

# KT-LED27HID-H-E26-840-D-DP

1 2 3 4 5 6 7 8 9 10

- 1 Keystone Technologies
- 2 LED Lamp
- 3 Wattage
- 4 Lamp Type
- 5 Horizontal Orientation
- 6 Base Type
- 7 800 Series
- 8 Color Temperature
- 9 DirectDrive Series
- 10 Packaging Style