



# KT-WPLED55-M1-8CSB-VDIM

## TRADITIONAL 55W NON-CUTOFF LED WALL PACK

**DESCRIPTION**

Traditional 55W Non-Cutoff LED Wall Pack | 120–277V Input | 3000–5000K | Medium-Size Bronze Housing | Glass Lens

**APPLICATION**

Building Mount for exterior illumination (perimeters, pathways, loading docks, and other general security lighting requirements)



**PRODUCT FEATURES**

- Traditional design matches appearance and light distribution pattern of legacy HID, optimized for one-for-one replacements
- Heavy-duty, die-cast aluminum housing with (5) available 1/2" threaded conduit hubs: (1) on back and (1) on all four sides
- Powered by Keystone 0–10V dimming LED drivers
- Keystone Color Select Technology: Adjustable CCT (3000K, 4000K, or 5000K)
- Built-in dusk-to-dawn photocell behind translucent 3/4" threaded plug with anti-yellowing agent
- Borosilicate glass lens diffuses light source and provides uniform distribution
- Covers footprint of mid-size HID wallpacks
- Ambient operating temperature: –20°C/–4°F to 45°C/113°F
- UL listed for wet locations, IP65
- 0–10V dimming, 10% min
- Power Factor: >0.95
- THD: <20%
- LED chip lifetime: L70 >100,000 hrs @ 25°C/77°F ambient fixture temp
- Meets FCC Part 15, Part B, Class A standards for conducted and radiated emissions

**ELECTRICAL SPECIFICATIONS**

Catalog Number	Wattage	Lumens	Lumens Below 90°	Dimming	CCT*	Efficacy	CRI	Housing Color	Input Voltage	Rated Life	Legacy Equivalent
KT-WPLED55-M1-8CSB-VDIM	55W	7645 lm	6345 lm	0–10V	3000K	139 lm/W	>80	Bronze	120–277V	50,000 hrs	175–250W MH
		7920 lm	6570 lm		4000K	144 lm/W					
		7370 lm	6115 lm		5000K	134 lm/W					

\* Color Uniformity: CCT (Correlated Color Temperature) range as per guidelines outlined in ANSI C78.377-2017



# KT-WPLED55-M1-8CSB-VDIM

## TRADITIONAL 55W NON-CUTOFF LED WALL PACK

**PHOTOMETRIC SPECIFICATIONS**

**ISOCANDELA PLOT**

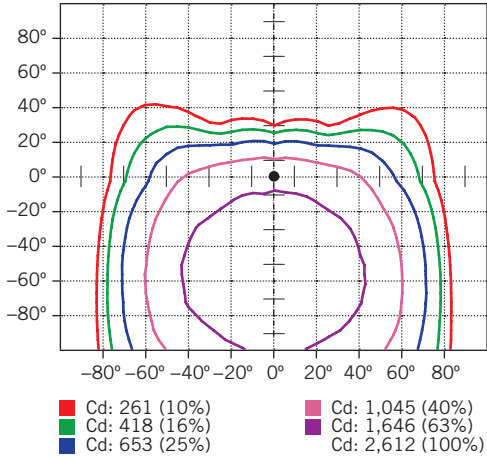

**LUMINOUS INTENSITY DISTRIBUTION**

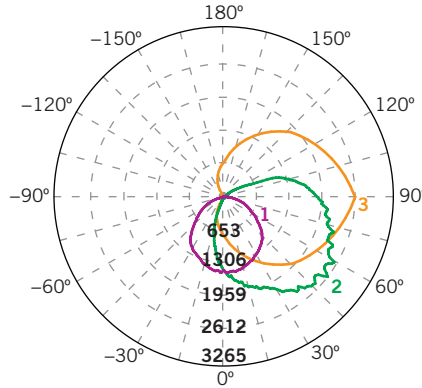

Average diffuse angle (50%): **109.9°**

- 1 Violet C0-C180
- 2 Green C90-C270
- 3 Orange G52

Unit: cd

**FLUX DISTRIBUTION**

Zone	Lumens	% Luminaire
<b>Forward Light</b>	4,931 lm	69.1%
0°-30°	725 lm	10.2%
30°-60°	2,050 lm	28.7%
60°-80°	1,508 lm	21.1%
80°-90°	649 lm	9.1%
<b>Back Light</b>	954 lm	13.4%
0°-30°	407 lm	5.7%
30°-60°	412 lm	5.8%
60°-80°	118 lm	1.6%
80°-90°	18 lm	0.2%
<b>Up Light</b>	1,251 lm	17.5%
90°-100°	529 lm	7.4%
100°-180°	722 lm	10.1%

**BUG\* Rating**

Asymmetrical Luminaire Types	
Type I, II, III, IV	B1 U5 G4
Quadrilateral Symmetrical Luminaire Types	
Type V, Area Light	B1 U5 G4

\* Backlight, Uplight, Glare

**MOUNTING**

Side view

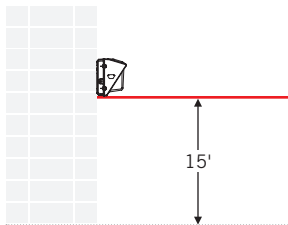

**LIGHT DISTRIBUTION PATTERN**

Isometric view from above; Luminaire mounted at 15'

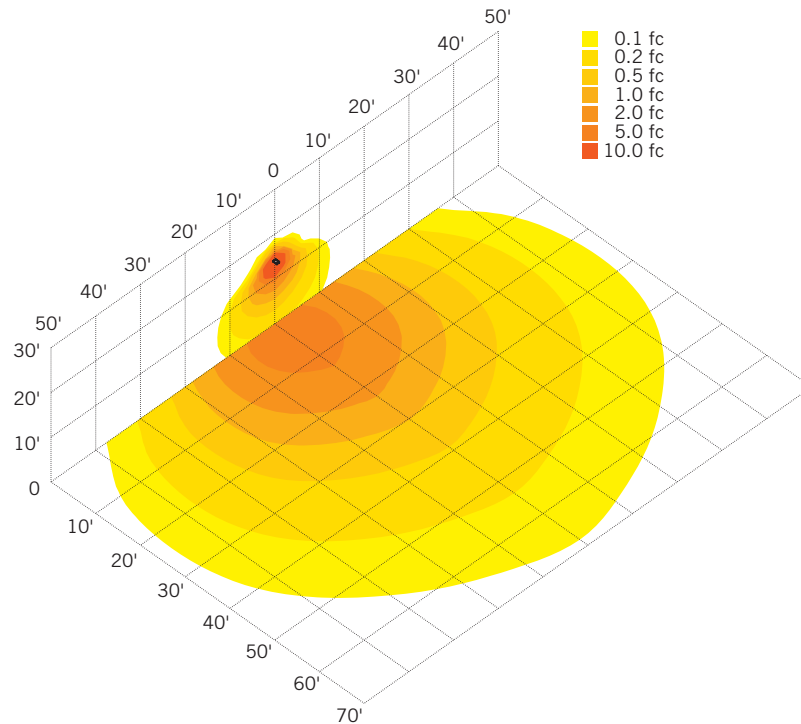



# XFIT | TRADITIONAL WALL PACK FIXTURES

## KT-WPLED55-M1-8CSB-VDIM TRADITIONAL 55W NON-CUTOFF LED WALL PACK

### PHYSICAL SPECIFICATIONS

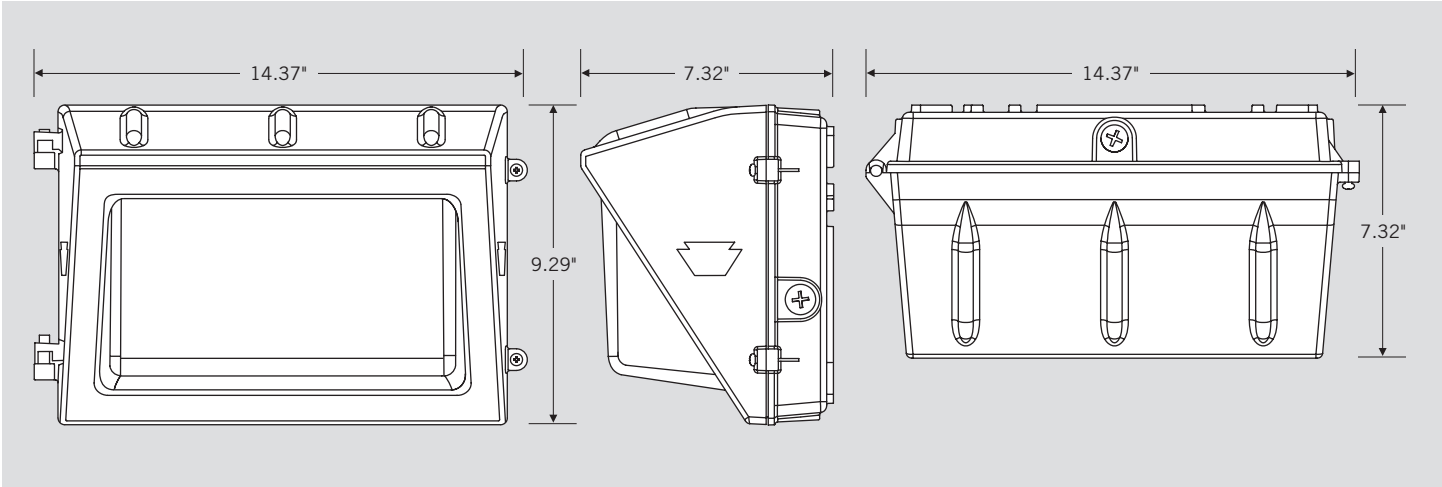

### GENERAL SETUP INSTRUCTIONS

#### GENERAL WIRING DIAGRAM

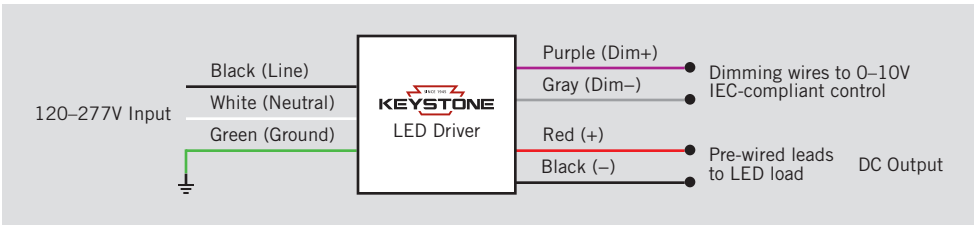

**Caution:** Before installing, make certain that AC power to the fixture is off.

**Caution:** The electrical rating of this product is 120-277V. Installer must confirm that there is 120-277V at the fixture before installation.

#### PHOTOCELL ENABLE/DISABLE

This fixture is equipped with a dusk-to-dawn photocell behind the translucent knock-out (KO) cover. Adjust the dip switch to enable (ON) or disable (OFF) the photocell function (see illustrations to the right). Fixture comes preset with photocell enabled unless otherwise noted.

#### COLOR SELECT (CCT) ADJUSTMENT

This fixture is equipped with Color Select technology. There is an adjustable dip switch behind the translucent knock-out (KO) cover to change CCT between 5000K, 4000K, and 3000K (see illustrations to the right). Fixture comes preset at 5000K unless otherwise noted.

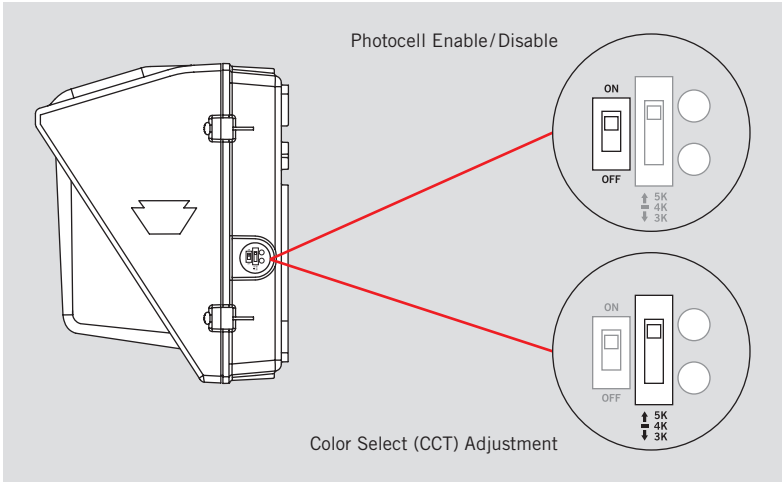



# KT-WPLED55-M1-8CSB-VDIM

## TRADITIONAL 55W NON-CUTOFF LED WALL PACK

**ACCESSORY (SOLD SEPARATELY)**

Catalog Number	Description
KTSP-10KV-C	Wallpack 10kV Surge Protector, Compact Design

**ORDERING INFORMATION**

CATALOG NUMBER	PACK QTY.	EASY CODE	UPC
KT-WPLED55-M1-8CSB-VDIM	1	BYJ-72	843654129020

**CATALOG NUMBER BREAKDOWN**

# KT-WPLED55-M1-8CSB-VDIM /XXX

1	2	3	4	5	6	7	8	9	10	11
<b>1 Keystone Technologies</b>	<b>2 Fixture Type</b>	<b>3 LED Lamp</b>	<b>4 Max Wattage</b>	<b>5 Size</b>	<b>6 Style</b>	<b>7 CRI</b>	<b>8 Color</b>	<b>9 Color Select Designation</b>	<b>10 Dimming</b>	<b>11 Sensor Options</b>
	F Flood			S Small	1 Non-Cutoff	8 >80	40 4000K	A 3500K, 4000K, 5000K	VDIM 0-10V	/XXX No option
	WP Wallpack			M Medium	2 Full-Cutoff	9 >90	50 5000K	B 3000K, 4000K, 5000K		/PIR Occupancy sensor included
				L Large			CS Color Select	C 3000K, 3500K, 4000K, 5000K		
								D TBD		