



# KT-WPLED35-M1-8CSB-VDIM-W

## TRADITIONAL 35W NON-CUTOFF LED WALL PACK

**DESCRIPTION**

Traditional 35W Non-Cutoff LED Wall Pack | 120–277V Input | 3000–5000K | Medium-Size White Housing | Glass Lens

**APPLICATION**

Building Mount for exterior illumination (perimeters, pathways, loading docks, and other general security lighting requirements)

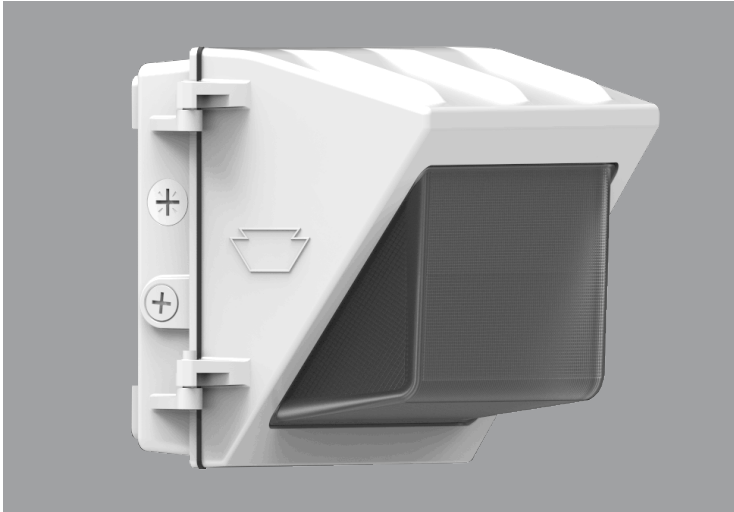

**PRODUCT FEATURES**

- Traditional design matches appearance and light distribution pattern of legacy HID, optimized for one-for-one replacements
- Heavy-duty, die-cast aluminum housing with (5) available 1/2" threaded conduit hubs: (1) on back and (1) on all four sides
- Powered by Keystone 0–10V dimming LED drivers
- Keystone Color Select Technology: Adjustable CCT (3000K, 4000K, or 5000K)
- Built-in dusk-to-dawn photocell behind translucent 3/4" threaded plug with anti-yellowing agent
- Borosilicate glass lens diffuses light source and provides uniform distribution
- Covers footprint of mid-size HID wallpacks
- Ambient operating temperature: –40°C/–40°F to 50°C/122°F
- UL listed for wet locations, IP65
- 0–10V dimming, 10% min
- Power Factor: >0.95
- THD: <20%
- LED chip lifetime: L70 >100,000 hrs @ 25°C/77°F ambient fixture temp
- Meets FCC Part 15, Part B, Class A standards for conducted and radiated emissions
- Fixture impact rating IK06
- Compatible with Keystone LED Emergency Backups

**ELECTRICAL SPECIFICATIONS**

Catalog Number	Wattage	Lumens	Lumens Below 90°	Dimming	CCT*	Efficacy	CRI	Housing Color	Input Voltage	Rated Life	Legacy Equivalent
KT-WPLED35-M1-8CSB-VDIM-W	35W	4885 lm	4400 lm	0–10V	3000K	140 lm/W	>80	White	120–277V	50,000 hrs	150W MH
		5460 lm	4910 lm		4000K	156 lm/W					
		5010 lm	4505 lm		5000K	143 lm/W					

\* Color Uniformity: CCT (Correlated Color Temperature) range as per guidelines outlined in ANSI C78.377-2017



# KT-WPLED35-M1-8CSB-VDIM-W

## TRADITIONAL 35W NON-CUTOFF LED WALL PACK

**PHOTOMETRIC SPECIFICATIONS**

**ISOCANDELA PLOT**

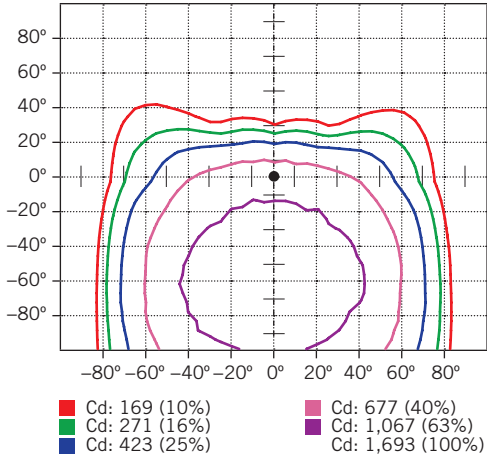

**LUMINOUS INTENSITY DISTRIBUTION**

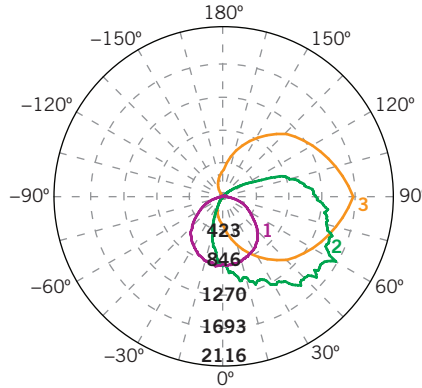

Average diffuse angle (50%): **111.0°**

- 1 Violet C0-C180
- 2 Green C90-C270
- 3 Orange G60

Unit: cd

**FLUX DISTRIBUTION**

Zone	Lumens	% Luminaire
<b>Forward Light</b>	3,845 lm	79.5%
0°-30°	591 lm	12.2%
30°-60°	1,673 lm	34.6%
60°-80°	1,166 lm	24.1%
80°-90°	416 lm	8.6%
<b>Back Light</b>	507 lm	10.5%
0°-30°	210 lm	4.4%
30°-60°	227 lm	4.7%
60°-80°	59 lm	1.2%
80°-90°	10 lm	0.2%
<b>Up Light</b>	481 lm	9.9%
90°-100°	215 lm	4.4%
100°-180°	267 lm	5.5%

**BUG\* Rating**

Asymmetrical Luminaire Types	
Type I, II, III, IV	B1 U3 G3
Quadrilateral Symmetrical Luminaire Types	
Type V, Area Light	B1 U3 G3

\* Backlight, Uplight, Glare

**MOUNTING**

Side view

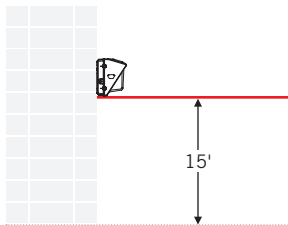

**LIGHT DISTRIBUTION PATTERN**

Isometric view from above; Luminaire mounted at 15'

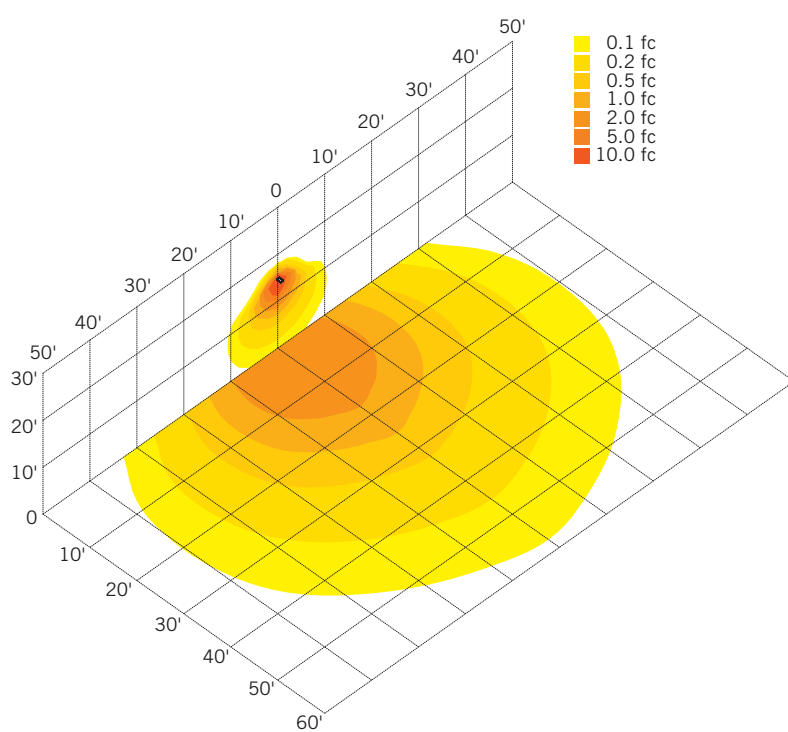



# XFIT | TRADITIONAL WALL PACK FIXTURES

## KT-WPLED35-M1-8CSB-VDIM-W TRADITIONAL 35W NON-CUTOFF LED WALL PACK

### PHYSICAL SPECIFICATIONS

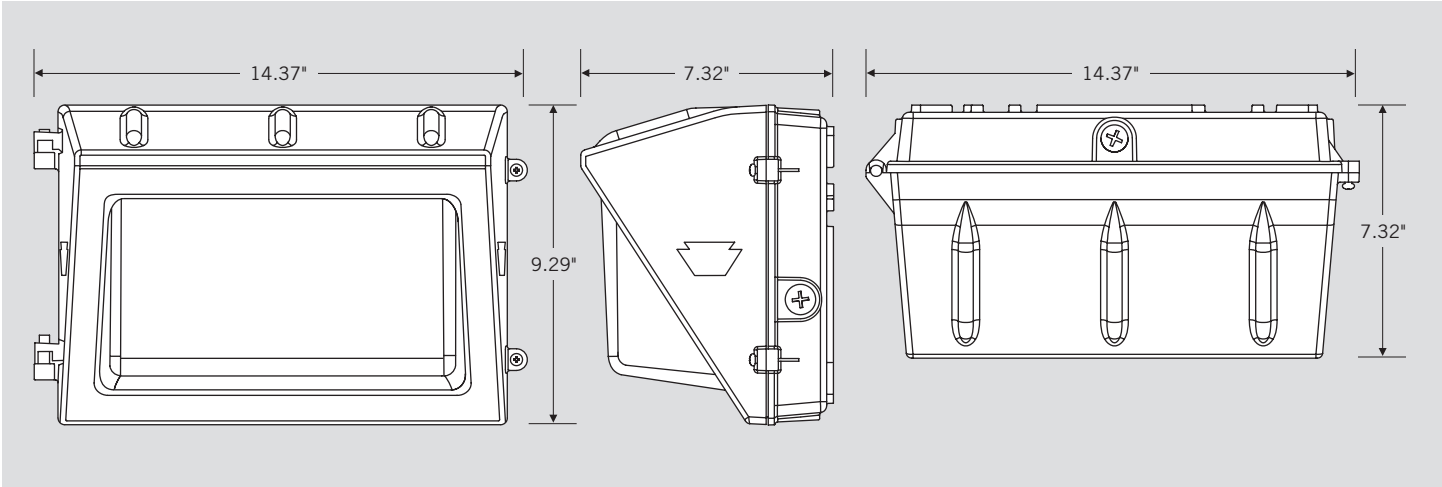

### GENERAL SETUP INSTRUCTIONS

#### GENERAL WIRING DIAGRAM

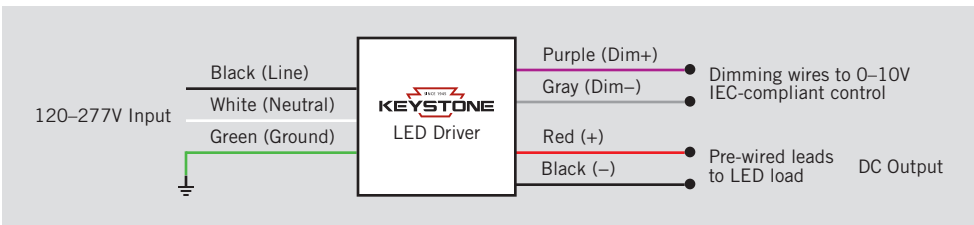

**Caution:** Before installing, make certain that AC power to the fixture is off.

**Caution:** The electrical rating of this product is 120-277V. Installer must confirm that there is 120-277V at the fixture before installation.

#### PHOTOCELL ENABLE/DISABLE

This fixture is equipped with a dusk-to-dawn photocell behind the translucent knock-out (KO) cover. Adjust the dip switch to enable (ON) or disable (OFF) the photocell function (see illustrations to the right). Fixture comes preset with photocell enabled unless otherwise noted.

#### COLOR SELECT (CCT) ADJUSTMENT

This fixture is equipped with Color Select technology. There is an adjustable dip switch behind the translucent knock-out (KO) cover to change CCT between 5000K, 4000K, and 3000K (see illustrations to the right). Fixture comes preset at 5000K unless otherwise noted.

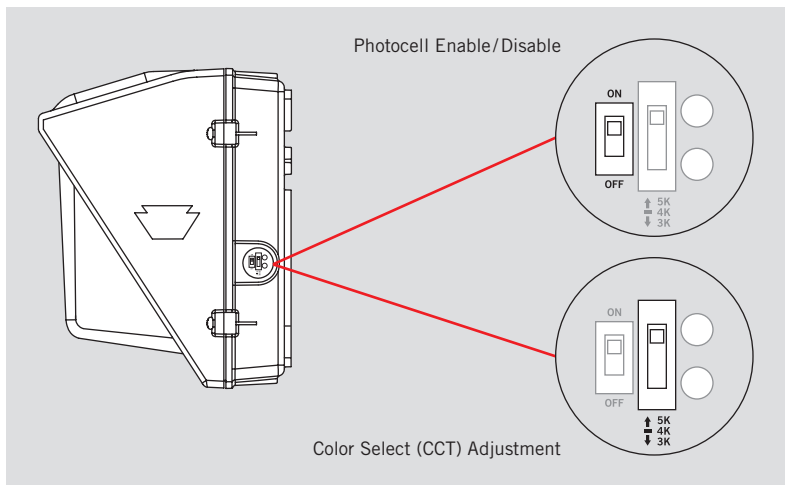



# KT-WPLED35-M1-8CSB-VDIM-W

## TRADITIONAL 35W NON-CUTOFF LED WALL PACK

**ACCESSORY (SOLD SEPARATELY)**

Catalog Number	Description
KTSP-10KV-C	Wallpack 10kV Surge Protector, Compact Design

**ORDERING INFORMATION**

CATALOG NUMBER	PACK QTY.	EASY CODE	UPC
KT-WPLED35-M1-8CSB-VDIM-W	1	RWQ-70	843654133676

**CATALOG NUMBER BREAKDOWN**

# KT-WPLED35-M1-8CSB-VDIM-W

- 1
- 2
- 3
- 4
- 5
- 6
- 7
- 8
- 9
- 10
- 11
- 12

- 1 Keystone Technologies
- 2 Fixture Type
- 3 LED Lamp
- 4 Max Wattage
- 5 Size
- 6 Style
- 7 CRI
- 8 Color
- 9 Color Select Designation
- 10 Dimming
- 11 Housing Colors
- 12 Sensor Options

**2 Fixture Type**

F	Flood
WP	Wallpack

**5 Size**

S	Small
M	Medium
L	Large

**6 Style**

1	Non-Cutoff
2	Full-Cutoff

**7 CRI**

8	>80
9	>90

**8 Color**

40	4000K
50	5000K
CS	Color Select

**9 Color Select Designation**

A	3500K, 4000K, 5000K
B	3000K, 4000K, 5000K
C	3000K, 3500K, 4000K, 5000K
D	TBD

**10 Dimming**

VDIM	0-10V
------	-------

**11 Housing Color**

	Bronze
B	Black
W	White

**12 Sensor Options**

	No option
/MW	Microwave occupancy Sensor Installed