



# KT-LED82P-V-8xx-D

## 2-PIN LED LAMP

### DESCRIPTION

8W 2-Pin LED Lamp | 2700K, 3000K, 3500K, 4000K, 5000K |  $\geq 83$  CRI



<b>LAMP TYPE:</b> Compact
<b>BULB TYPE:</b> 2-Pin LED
<b>BASE TYPE:</b> G24d, G24q, GX24q
<b>WATTAGE:</b> 8W
<b>COLOR TEMPERATURE:</b> 2700K, 3000K, 3500K, 4000K, 5000K
<b>COLOR RENDERING INDEX (CRI):</b> $\geq 83$
<b>WARRANTY:</b> 5 Years



### PRODUCT FEATURES

- Replaces 26W/32W/42W G24d, G24q & GX24q\* CFL Lamps
- 50,000+ Hour Lifetime
- Approximately 50% More Energy Efficient than Traditional CFL Lamps
- Environmentally Friendly: No Mercury Used
- Instant Startup
- Frosted Lens Eliminates Pixelation
- Integral Driver, Eliminates the Need for External Driver or Ballast
- UL Recognized and UL Classified
- Operating Temperature: -20°C/-4°F to 45°C/113°F
- Up to 5x Longer Life than Traditional CFL Lamps
- Vertical Orientation
- Suitable for use in fully enclosed fixture. Minimum lamp compartment dimensions: 12cm X 15cm

\*G24q-5/6/7 and Gx24q-5/6/7 not compatible

### OPERATING SPECIFICATIONS

#### ELECTRICAL CHARACTERISTICS

Input Voltage	Lamp Wattage	Power Factor	System Wattage
120-277V	8W	>0.9	8W

#### PHOTOMETRIC CHARACTERISTICS

Color Temperature (CCT)	2700K	3000K	3500K	4000K	5000K
<b>Luminous Flux</b>	900 lm	900 lm	900 lm	950 lm	950 lm
<b>Color Rendering Index (CRI)</b>	$\geq 83$	$\geq 83$	$\geq 83$	$\geq 83$	$\geq 83$
<b>Bare Lamp Efficacy</b>	113 lm/W	113 lm/W	113 lm/W	119 lm/W	119 lm/W
<b>Beam Angle</b>	>120°	>120°	>120°	>120°	>120°

#### RATED LIFE

L70 (Hours)	50,000
-------------	--------

#### POLAR CANDELA DISTRIBUTION

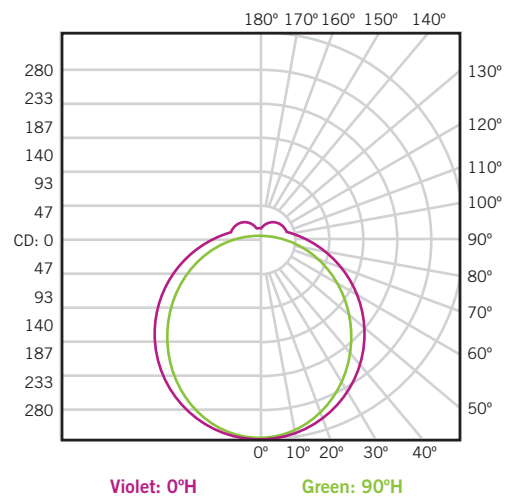

# KT-LED82P-V-8xx-D

## 2-PIN LED LAMP

### WIRING

#### BYPASS MAGNETIC BALLAST WITH 1 LAMP

**BEFORE**

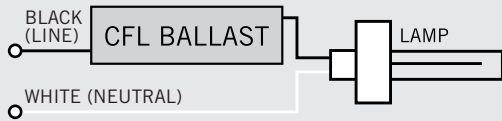

**AFTER**

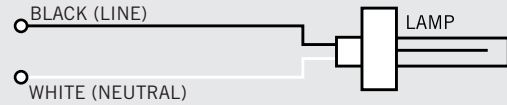

#### BYPASS ELECTRONIC BALLAST WITH 1 LAMP

**BEFORE**

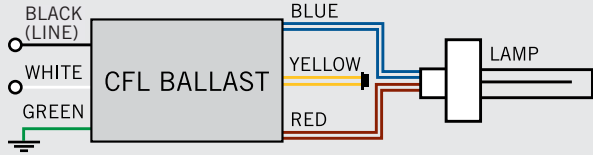

**AFTER**

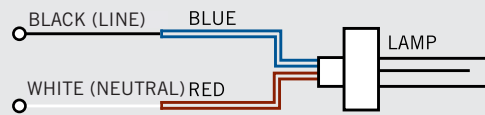

#### BYPASS MAGNETIC BALLAST WITH 2 LAMPS

**BEFORE**

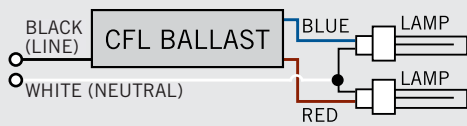

**AFTER**

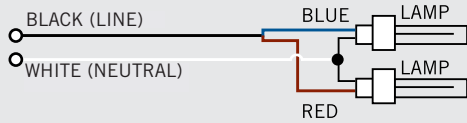

#### BYPASS ELECTRONIC BALLAST WITH 2 LAMPS

**BEFORE**

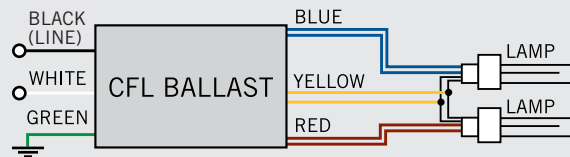

**AFTER**

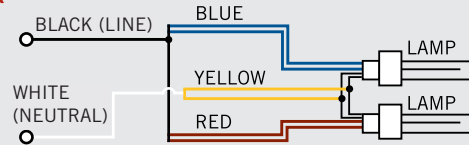

### PHYSICAL CHARACTERISTICS

#### LAMP DIMENSIONS

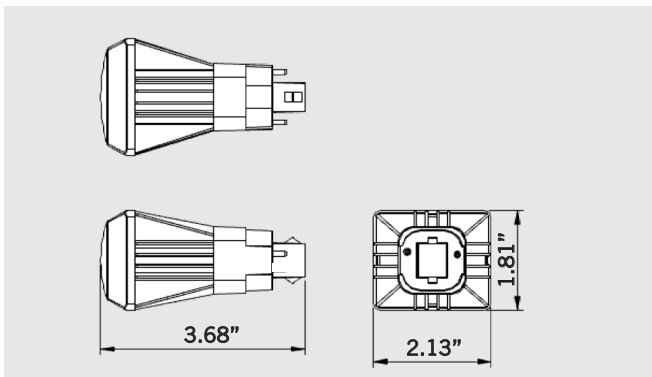



# KT-LED82P-V-8xx-D

## 2-PIN LED LAMP

### ORDERING INFORMATION

ORDER CODE	PACK QTY.	UPC	ITEM STATUS
KT-LED82P-V-827-D-DP	50	89094901274	FGO-45
KT-LED82P-V-830-D-DP	50	89094901275	IWR-13
KT-LED82P-V-835-D-DP	50	89094901276	XHT-14
KT-LED82P-V-840-D-DP	50	89094901277	KVM-23
KT-LED82P-V-850-D-DP	50	89094901278	ISC-98

### CATALOG NUMBER BREAKDOWN

# KT-LED82P-V-8XX-D

1 2 3 4 5 6 7 8

- 1 Keystone Technologies
- 2 LED Lamp
- 3 Wattage
- 4 Lamp Type
- 5 Orientation
- 6 800 Series
- 7 Color Temperature
- 8 Combo Drive Series