



KT-LED8PLL-9GC-8XX-D

PLL LED LAMP

DESCRIPTION

8.5W PLL LED | 3000-5000K | >80 CRI | High-Efficiency



LAMP TYPE: PLL
BASE TYPE: 2G11
WATTAGE: 8.5W
COLOR TEMPERATURE: 3000-5000K
COLOR RENDERING INDEX (CRI): >80
WARRANTY: 5 Years

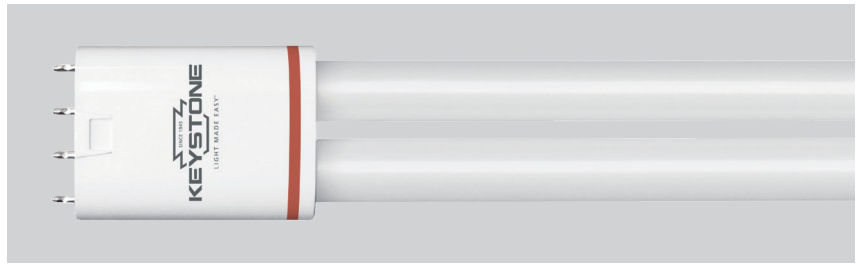

PRODUCT FEATURES

- Replacement for conventional fluorescent lamp
- UL Classified
- 50,000+ hour lifetime
- Approximately 50% more energy efficient than standard FT40/2G11 lamps
- Environmentally friendly: No mercury used
- Integral driver (isolated) eliminates the need for an external ballast or driver
- Instant startup
- Not dimmable
- Frosted lens eliminates pixelation
- Operating temperature: -20°C/-4°F to 45°C/113°F
- 100+ Lumens per Watt (bare lamp efficacy)
- Suitable for dry and damp locations
- NSF Listed: NSF/ANSI Standard 2 - Food Equipment
- Suitable for use in fully enclosed fixture. Minimum lamp compartment dimensions: 44cm x 14cm x 10cm

OPERATING SPECIFICATIONS

ELECTRICAL AND PERFORMANCE CHARACTERISTICS

Catalog Number	Input Voltage	CRI	Wattage	Nominal Lumens	Color Temp.	Beam Angle	Efficacy	Power Factor	Max. THD
KT-LED8PLL-9GC-830-D	120-277V	>80	8.5W	950	3000K	160°	112 lm/W	>0.9	20%
KT-LED8PLL-9GC-835-D	120-277V	>80	8.5W	950	3500K	160°	112 lm/W	>0.9	20%
KT-LED8PLL-9GC-840-D	120-277V	>80	8.5W	980	4000K	160°	115 lm/W	>0.9	20%
KT-LED8PLL-9GC-850-D	120-277V	>80	8.5W	980	5000K	160°	115 lm/W	>0.9	20%

PHOTOMETRIC SPECIFICATIONS

ISOCANDELA PLOT

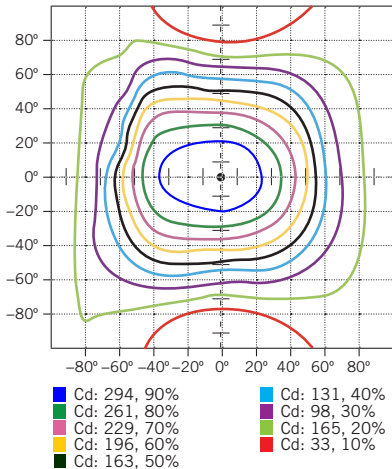

POLAR CANDELA DISTRIBUTION

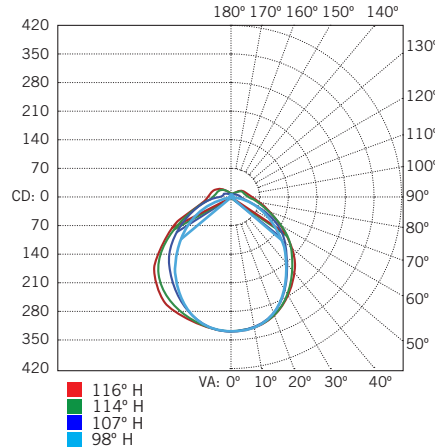

LUX DISTANCE CURVE

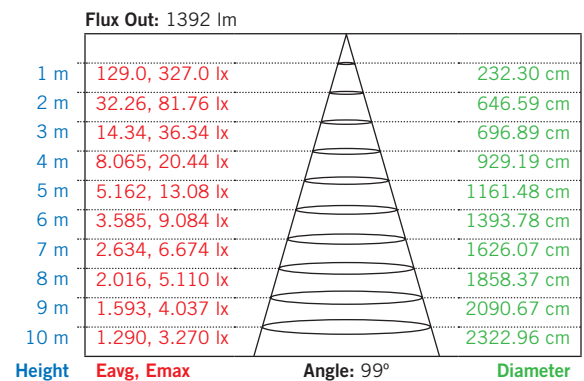

NOTE: Charts are represented by 5000K

KT-LED8PLL-9GC-8XX-D
PLL LED LAMP

WIRING DIAGRAMS

1. Cut all existing connections to ballast as shown below and remove ballast.

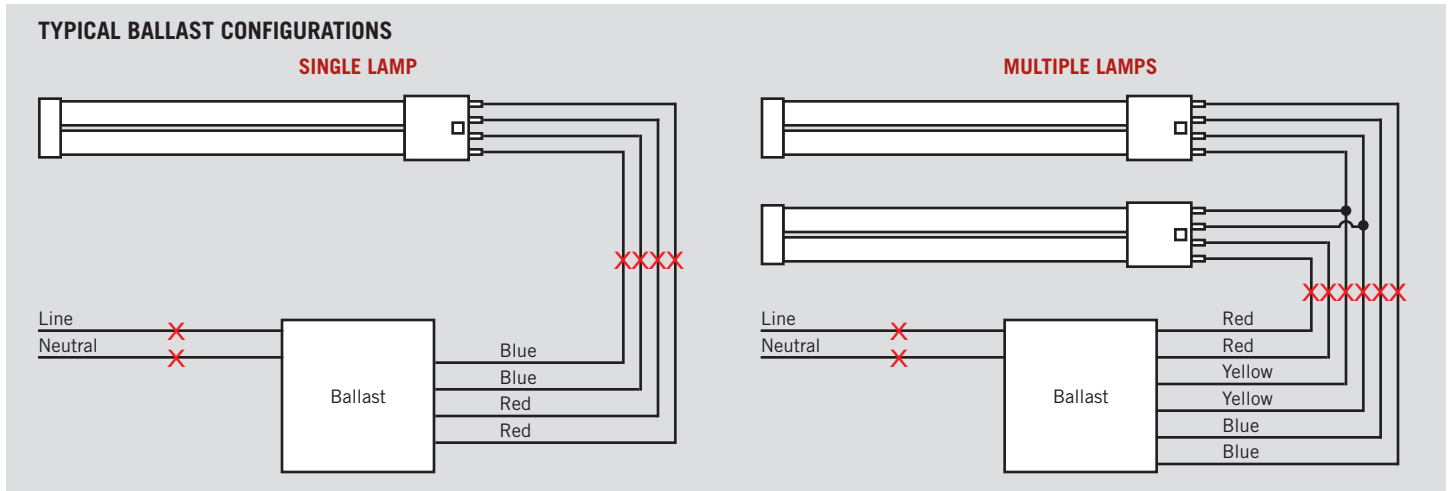

2. Re-wire fixture as shown below.

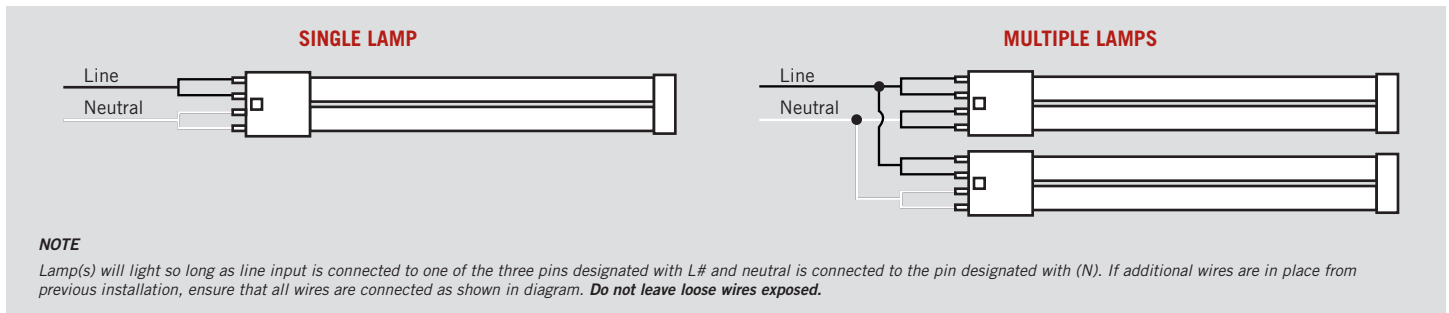

PHYSICAL CHARACTERISTICS

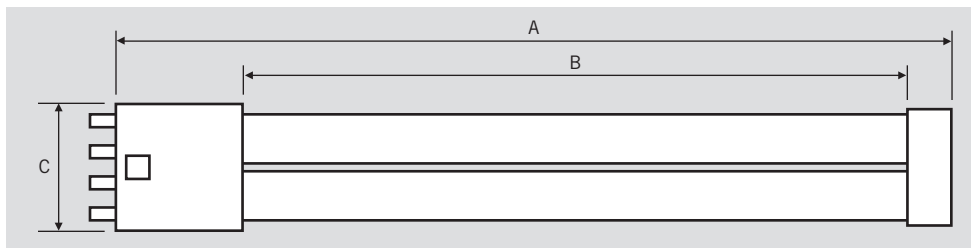

LAMP DIMENSIONS

A (Body Length)	8.5"
B (Illuminated Length)	5.5"
C (Width)	1.7"

BASE TYPE: 2G11



KT-LED8PLL-9GC-8XX-D

PLL LED LAMP

ORDERING INFORMATION

ORDER CODE	PACK QTY.	EASY CODE	UPC
KT-LED8PLL-9GC-830-D	24	MAK-25	843654131221
KT-LED8PLL-9GC-835-D	24	GSP-32	843654131238
KT-LED8PLL-9GC-840-D	24	ELU-16	843654131245
KT-LED8PLL-9GC-850-D	24	IFT-61	843654131252

CATALOG NUMBER BREAKDOWN

KT-LED8PLL-9GC-8XX-D

1 2 3 4 5 6 7 8 9

- 1 Keystone Technologies
- 2 LED Lamp
- 3 Wattage
- 4 Lamp Type
- 5 Nominal Length (Inches)
- 6 Glass
- 7 800 Series
- 8 Color Temperature
- 9 Direct-Drive Series