



KT-LED162P-V-8XX-D

2-PIN LED LAMP



DESCRIPTION

16W 2-Pin LED Lamp | 2700-5000K | ≥80 CRI

LAMP TYPE: Compact
BULB TYPE: 2-Pin LED
BASE TYPE: G24q, Gx24q, G24d and Gx24d
WATTAGE: 16W
COLOR TEMPERATURE: 2700-5000K
COLOR RENDERING INDEX (CRI): ≥80
WARRANTY: 5 Years



PRODUCT FEATURES

- Replaces 42W G24q, Gx24q, G24d and Gx24d
- 50,000+ hour lifetime
- Approximately 50% more energy efficient than traditional CFL lamps
- Environmentally friendly: no mercury used
- Instant startup
- Not for use in fully enclosed fixtures. Minimum compartment dimensions allowed 20cm X 24cm.
- Frosted lens eliminates pixelation
- Integral driver, eliminates the need for external driver or ballast
- UL Recognized and UL Classified
- Operating temperature: -20°C/-68°F to 40°C/104°F
- Up to 5x longer life than traditional CFL lamps
- Vertical orientation
- Non-dimmable

OPERATING SPECIFICATIONS

ELECTRICAL CHARACTERISTICS

Input Voltage	Lamp Wattage	Power Factor	System Wattage
120-277V	16W	>0.9	16W

PHOTOMETRIC CHARACTERISTICS

Color Temperature (CCT)	2700K	3000K	3500K	4000K	5000K
Luminous Flux	1750 lm	1800 lm	1850 lm	1900 lm	2000 lm
Color Rendering Index (CRI)	≥80	≥80	≥80	≥80	≥80
Bare Lamp Efficacy	109 lm/W	113 lm/W	116 lm/W	119 lm/W	125 lm/W
Beam Angle	>110°	>110°	>110°	>110°	>110°

RATED LIFE

L70 (Hours)	50,000
--------------------	--------

POLAR CANDELA DISTRIBUTION

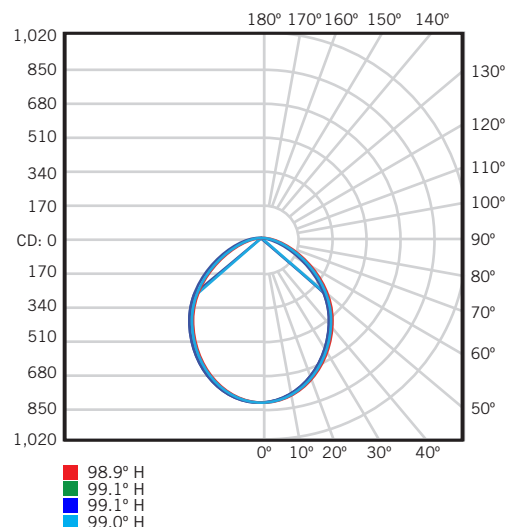



KT-LED162P-V-8XX-D

2-PIN LED LAMP

WIRING

BYPASS MAGNETIC BALLAST WITH 1 LAMP

BEFORE

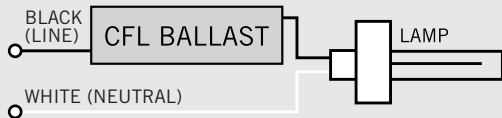

AFTER

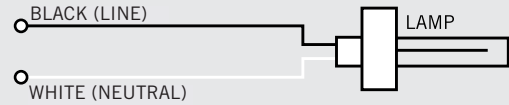

BYPASS ELECTRONIC BALLAST WITH 1 LAMP

BEFORE

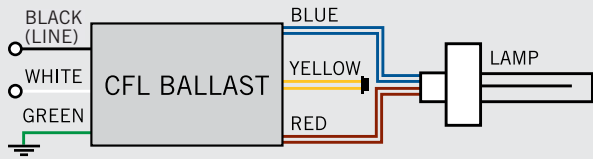

AFTER

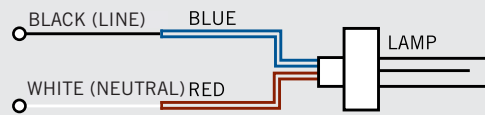

BYPASS MAGNETIC BALLAST WITH 2 LAMPS

BEFORE

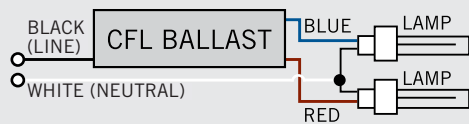

AFTER

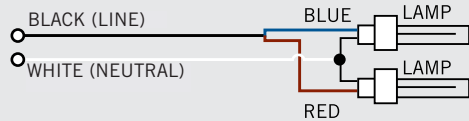

BYPASS ELECTRONIC BALLAST WITH 2 LAMPS

BEFORE

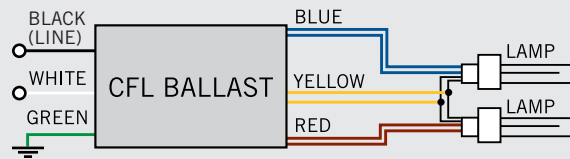

AFTER

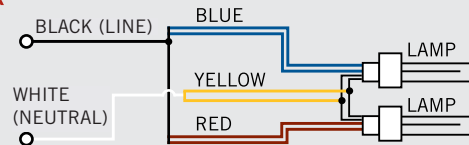

PHYSICAL CHARACTERISTICS

LAMP DIMENSIONS

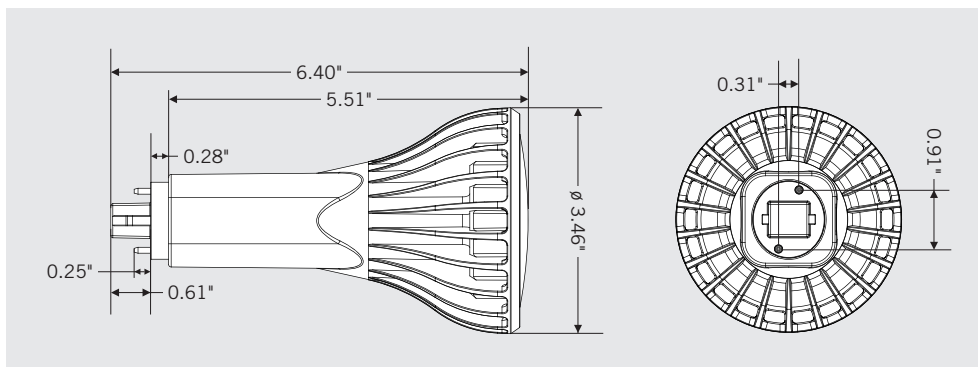



KT-LED162P-V-8XX-D

2-PIN LED LAMP

ORDERING INFORMATION

CATALOG NUMBER	PACK QTY.	EASY CODE	UPC
KT-LED162P-V-827-D-DP	24	YNF-80	843654127668
KT-LED162P-V-830-D-DP	24	RMU-71	843654127675
KT-LED162P-V-835-D-DP	24	ORV-07	843654127682
KT-LED162P-V-840-D-DP	24	ZUL-50	843654127699
KT-LED162P-V-850-D-DP	24	JZY-85	843654127705

CATALOG NUMBER BREAKDOWN

KT-LED162P-V-8XX-D

1 2 3 4 5 6 7 8

- 1 Keystone Technologies
- 2 LED Lamp
- 3 Wattage
- 4 Lamp Type
- 5 Orientation
- 6 800 Series
- 7 Color Temperature
- 8 Combo Drive Series