



KT-WPLED80-M1-8CSB-VDIM-W

TRADITIONAL 80W NON-CUTOFF LED WALL PACK

DESCRIPTION

Traditional 80W Non-Cutoff LED Wall Pack | 120–277V Input | 3000–5000K | Medium-Size White Housing | Glass Lens

APPLICATION

Building Mount for exterior illumination (perimeters, pathways, loading docks, and other general security lighting requirements)

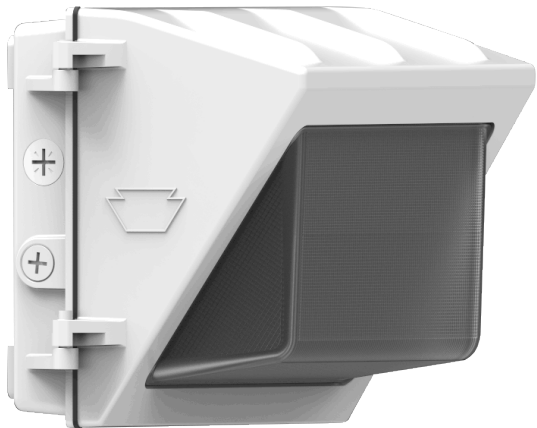

PRODUCT FEATURES

- Traditional design matches appearance and light distribution pattern of legacy HID, optimized for one-for-one replacements
- Heavy-duty, die-cast aluminum housing with (5) available 1/2" threaded conduit hubs: (1) on back and (1) on all four sides
- Powered by Keystone 0–10V dimming LED drivers
- Keystone Color Select Technology: Adjustable CCT (3000K, 4000K, or 5000K)
- Built-in dusk-to-dawn photocell behind translucent 3/4" threaded plug with anti-yellowing agent
- Borosilicate glass lens diffuses light source and provides uniform distribution
- Covers footprint of mid-size HID wallpacks
- Ambient operating temperature: –40°C/–40°F to 50°C/122°F
- UL listed for wet locations, IP65
- 0–10V dimming, 10% min
- Power Factor: >0.95
- THD: <20%
- LED chip lifetime: L70 >100,000 hrs @ 25°C/77°F ambient fixture temp
- Meets FCC Part 15, Part B, Class A standards for conducted and radiated emissions
- Fixture impact rating IK06
- Compatible with Keystone LED Emergency Backups

ELECTRICAL SPECIFICATIONS

Catalog Number	Wattage	Lumens	Lumens Below 90°	Dimming	CCT*	Efficacy	CRI	Housing Color	Input Voltage	Rated Life	Legacy Equivalent
KT-WPLED80-M1-8CSB-VDIM-W	80W	10955 lm	9860 lm	0–10V	3000K	137 lm/W	>80	White	120–277V	50,000 hrs	250–320W MH
		11925 lm	10730 lm		4000K	149 lm/W					
		11360 lm	10225 lm		5000K	142 lm/W					

* Color Uniformity: CCT (Correlated Color Temperature) range as per guidelines outlined in ANSI C78.377-2017



KT-WPLED80-M1-8CSB-VDIM-W

TRADITIONAL 80W NON-CUTOFF LED WALL PACK

PHOTOMETRIC SPECIFICATIONS

ISOCANDELA PLOT

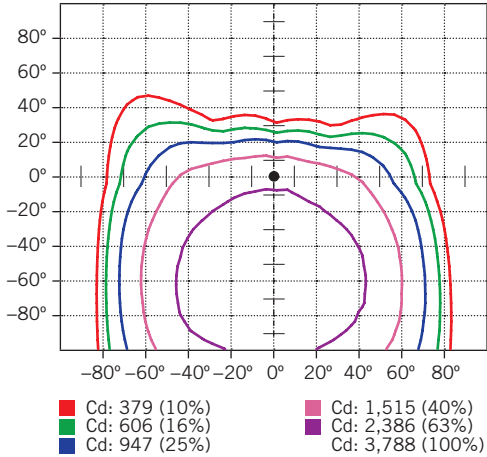

LUMINOUS INTENSITY DISTRIBUTION

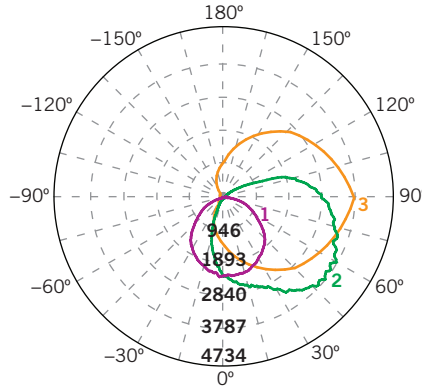

Average diffuse angle (50%): **111.4°**

- 1 Violet C0-C180
- 2 Green C90-C270
- 3 Orange G51

Unit: cd

FLUX DISTRIBUTION

Zone	Lumens	% Luminaire
Forward Light	8,671 lm	79.6%
0°-30°	1,281 lm	11.8%
30°-60°	3,696 lm	33.9%
60°-80°	2,660 lm	24.4%
80°-90°	1,035 lm	9.5%
Back Light	1,029 lm	9.5%
0°-30°	409 lm	3.8%
30°-60°	471 lm	4.3%
60°-80°	126 lm	1.2%
80°-90°	23 lm	0.2%
Up Light	1,195 lm	11.0%
90°-100°	551 lm	5.1%
100°-180°	644 lm	5.9%

BUG* Rating

Asymmetrical Luminaire Types	
Type I, II, III, IV	B1 U4 G5
Quadrilateral Symmetrical Luminaire Types	
Type V, Area Light	B1 U4 G5

* Backlight, Uplight, Glare

MOUNTING

Side view

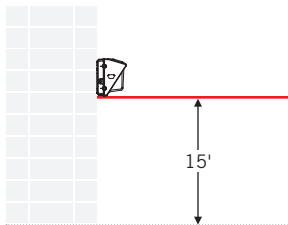

LIGHT DISTRIBUTION PATTERN

Isometric view from above; Luminaire mounted at 15'

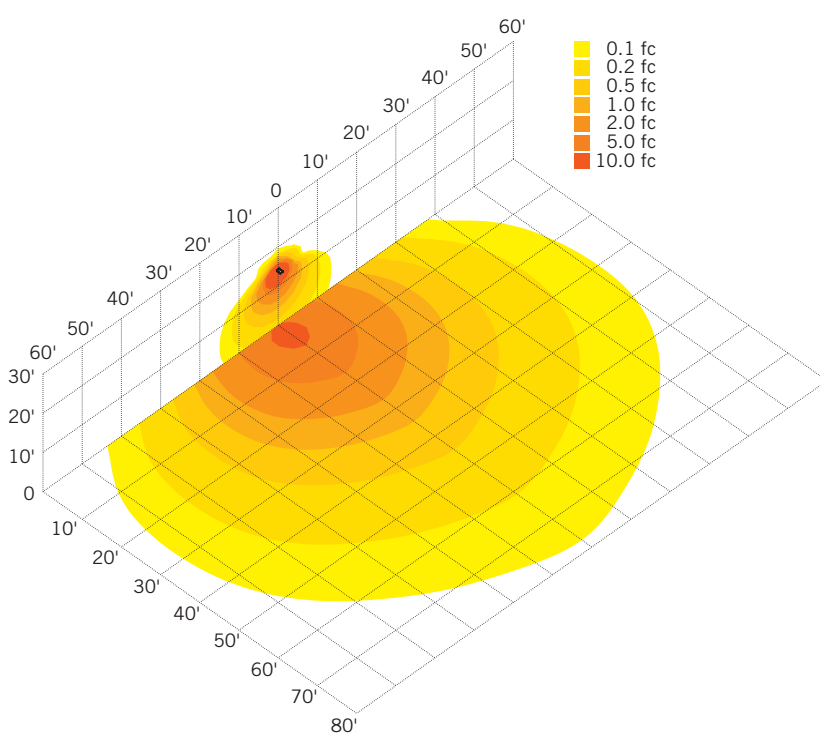



KT-WPLED80-M1-8CSB-VDIM-W

TRADITIONAL 80W NON-CUTOFF LED WALL PACK

PHYSICAL SPECIFICATIONS

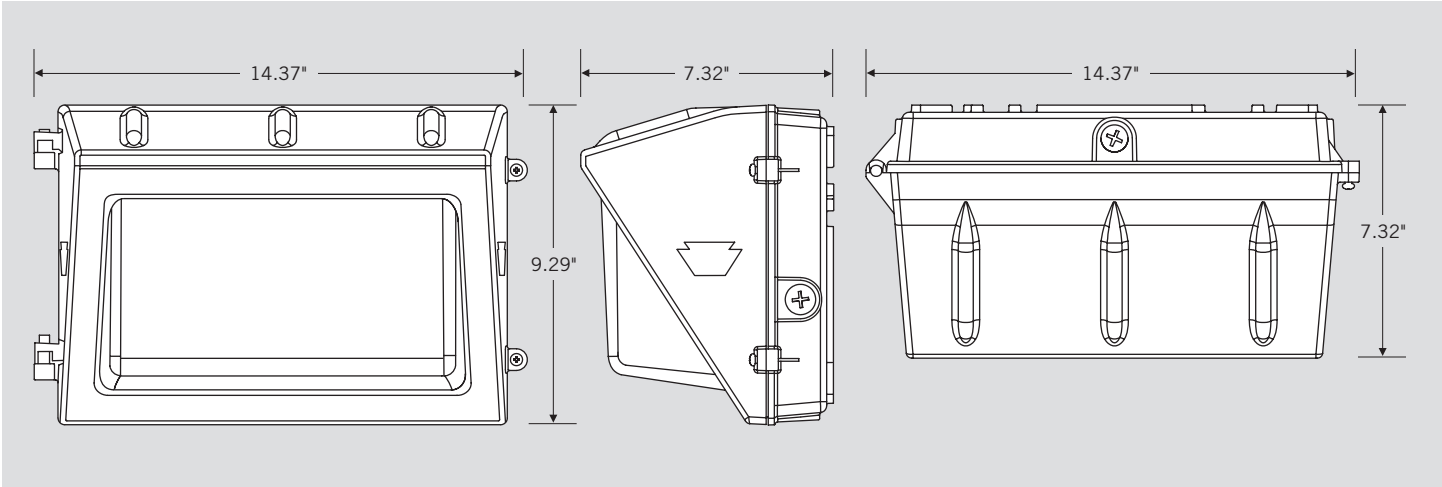

GENERAL SETUP INSTRUCTIONS

GENERAL WIRING DIAGRAM

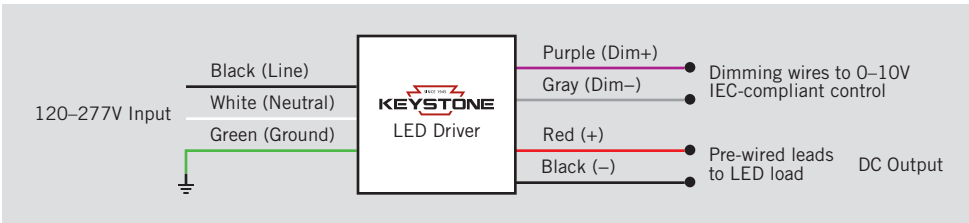

Caution: Before installing, make certain that AC power to the fixture is off.

Caution: The electrical rating of this product is 120-277V. Installer must confirm that there is 120-277V at the fixture before installation.

PHOTOCELL ENABLE/DISABLE

This fixture is equipped with a dusk-to-dawn photocell behind the translucent knock-out (KO) cover. Adjust the dip switch to enable (ON) or disable (OFF) the photocell function (see illustrations to the right). Fixture comes preset with photocell enabled unless otherwise noted.

COLOR SELECT (CCT) ADJUSTMENT

This fixture is equipped with Color Select technology. There is an adjustable dip switch behind the translucent knock-out (KO) cover to change CCT between 5000K, 4000K, and 3000K (see illustrations to the right). Fixture comes preset at 5000K unless otherwise noted.

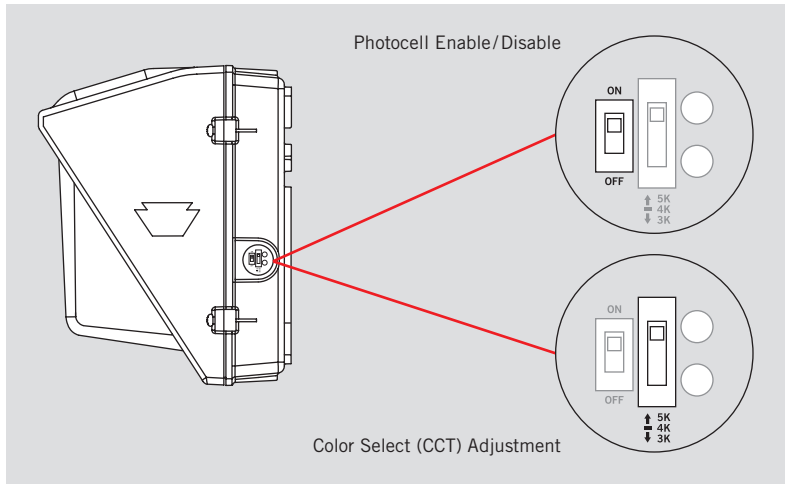



KT-WPLED80-M1-8CSB-VDIM-W

TRADITIONAL 80W NON-CUTOFF LED WALL PACK

ACCESSORY (SOLD SEPARATELY)

Catalog Number	Description
KTSP-10KV-C	Wallpack 10kV Surge Protector, Compact Design

ORDERING INFORMATION

CATALOG NUMBER	PACK QTY.	EASY CODE	UPC
KT-WPLED80-M1-8CSB-VDIM-W	1	VTP-56	843654133799

CATALOG NUMBER BREAKDOWN

KT-WPLED80-M1-8CSB-VDIM-W

1	2	3	4	5	6	7	8	9	10	11	12
1 Keystone Technologies	2 Fixture Type	3 LED Lamp	4 Max Wattage	5 Size	6 Style	7 CRI	8 Color	9 Color Select Designation	10 Dimming	11 Housing Color	12 Sensor Options
	F Flood			S Small	1 Non-Cutoff	8 >80	40 4000K	A 3500K, 4000K, 5000K	VDIM 0-10V	Bronze	No option
	WP Wallpack			M Medium	2 Full-Cutoff	9 >90	50 5000K	B 3000K, 4000K, 5000K		Black	/MW Microwave occupancy Sensor Installed
				L Large			CS Color Select	C 3000K, 3500K, 4000K, 5000K		White	
								D TBD			