



KT-LED45PSHID-EX39-8XX-D /G4

HID REPLACEMENT LED LAMP

DESCRIPTION

45W HID Replacement LED Lamp | Power Select | 80 CRI | IP64



LAMP TYPE: HID Replacement LED
BASE TYPE: EX39 (Mogul)
SELECTABLE WATTAGE: 45W, 36W, 27W
COLOR TEMPERATURE: 3000K, 4000K, 5000K
METAL HALIDE EQUIVALENT: 175W
COLOR RENDERING INDEX (CRI): > 80
WARRANTY: 5 Years

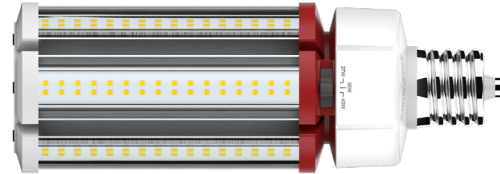

PRODUCT FEATURES

- Replacement for conventional metal halide lamp
- Environmentally friendly: No mercury used
- Instant startup
- Integral driver eliminates the need for external driver or ballast; includes 4kV surge protection
- Step dimmable with Power Select Switch. See below image.
- 50,000+ hour lifetime
- Operating temperature: -30°C/-22°F to 45°C/113°F
- Suitable for use in fully enclosed fixtures
- Minimum lamp compartment dimensions: 8.0" x 8.0" x 10.0"
- UL listed
- IP64 rated; integrated heat sink quickly dissipates heat and guides water intrusion out of the lamp

ELECTRICAL AND PERFORMANCE SPECIFICATIONS

Keystone Catalog Number	Input Voltage	Selectable Power	CCT	Lumens	Efficacy	Base Type	CRI	PF
KT-LED45PSHID-EX39-830-D /G4	120-277V	45W	3000K	6075	135 lm/W	EX39	>80	≥90
		36W		4860	135 lm/W			
		27W		3645	135 lm/W			
KT-LED45PSHID-EX39-840-D /G4	120-277V	45W	4000K	6300	140 lm/W	EX39	>80	≥90
		36W		5040	140 lm/W			
		27W		3780	140 lm/W			
KT-LED45PSHID-EX39-850-D /G4	120-277V	45W	5000K	6525	145 lm/W	EX39	>80	≥90
		36W		5220	145 lm/W			
		27W		3915	145 lm/W			

SELECTABILITY

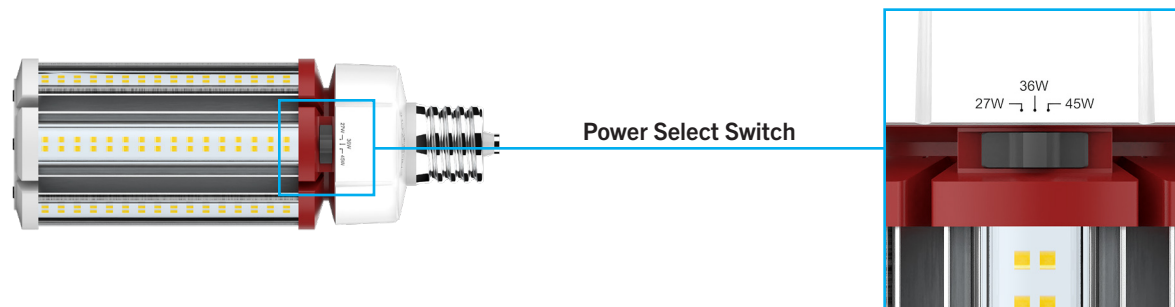



KT-LED45PSHID-EX39-8XX-D /G4

HID REPLACEMENT LED LAMP

PHYSICAL CHARACTERISTICS

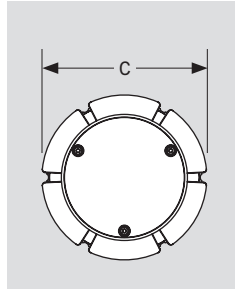
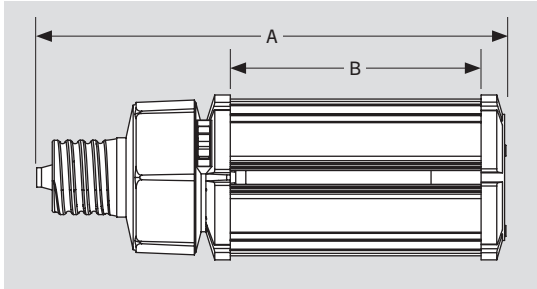

LAMP DIMENSIONS

A (Body Length)	9.49"
B (Illuminated Length)	5.55"
C (Diameter)	3.35"

BASE TYPE: EX39 (Mogul)

WIRING INSTRUCTIONS

STEP 1

Disconnect power. Disconnect and remove existing ballast, capacitor, and/or ignitor (where applicable) from fixture.

Note: Follow all federal and local regulations when disposing of lamps and removed components.

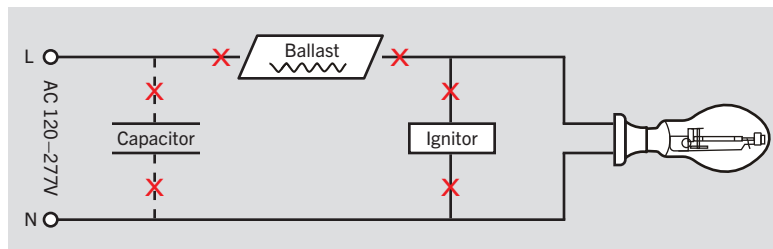

STEP 2

Rewire for line voltage to the lamp socket.

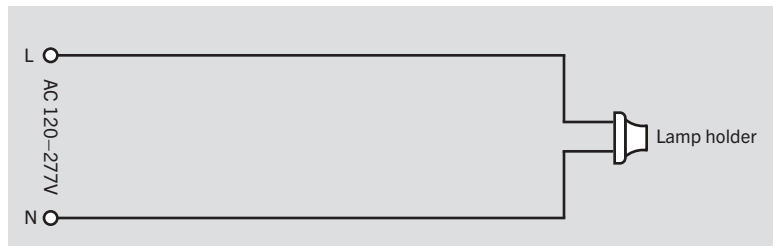

STEP 3

Install new LED replacement lamp. Ensure lamp is operating properly when power is turned on.

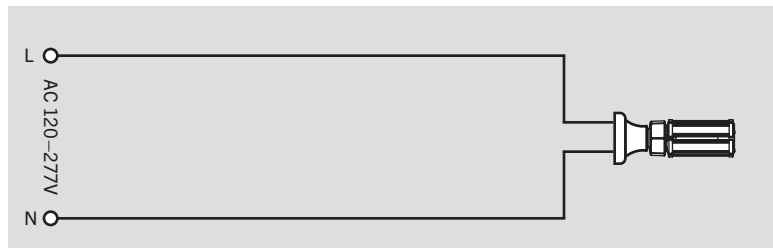
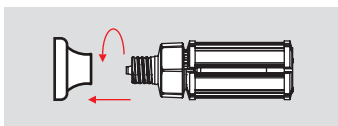

EX39-based lamps will work in *both* **E39** and **EX39** sockets.

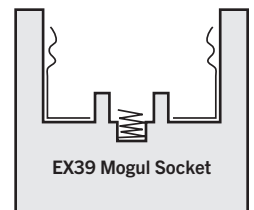
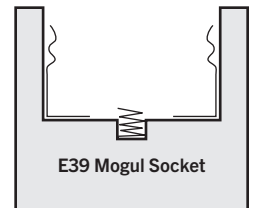



KT-LED45PSHID-EX39-8XX-D /G4

HID REPLACEMENT LED LAMP

ORDERING INFORMATION

ORDER CODE	PACK QTY.	UPC	EASY CODE
KT-LED45PSHID-EX39-830-D /G4	16	843654138305	ONB-12
KT-LED45PSHID-EX39-840-D /G4	16	843654138312	NLD-47
KT-LED45PSHID-EX39-850-D /G4	16	843654138329	JNR-15

CATALOG NUMBER BREAKDOWN

KT-LED45PSHID-EX39-8XX-D /G4

1 2 3 4 5 6 7 8 9 10

- 1 Keystone Technologies
- 2 LED Lamp
- 3 Wattage
- 4 Power Select
- 5 Lamp Type
- 6 Base Type
- 7 80 CRI
- 8 Color Temperature
- 9 Direct Drive
- 10 Fourth Generation