

KT-MSLED44PS-4-8CSA-VDIM

LED MICROSTRIP FIXTURE

DESCRIPTION

4' LED Microstrip Fixture | 120–277V Input | Frosted Lens | 0–10V Dimming

APPLICATION

Used for commercial, retail, and residential strip applications



PRODUCT FEATURES

- Features Keystone Color Select technology. Adjust CCT between 3500K, 4000K, or 5000K
- Features Keystone Power Select technology. Adjust power between 44W, 28W, and 18W
- Luminaire is suitable for installation within a clothes closet storage space
- Powered by Keystone 0–10V dimming LED drivers
- Post-painted steel body; PMMA lens
- Compatible with Keystone SmartSafe emergency LED drivers
- Compatible with Keystone occupancy sensors
- Ambient operating temperature: –20°C/–4°F to 50°C/122°F
- UL Listed 1598: Suitable for dry and damp locations
- THD: < 20%
- Power factor > 0.95

POWER AND COLOR TEMPERATURE SELECTABILITY

- Keystone Color Select Technology: Adjustable CCT (3500K/4000K/5000K)
- Keystone Power Select Technology: Adjustable Wattage (44W/28W/18W)

PRODUCT SPECIFICATIONS

Catalog Number	Input Voltage	Wattage	Color Temperature	Lumens	Efficacy	Rated Life	CRI	Power Factor
KT-MSLED44PS-4-8CSA-VDIM*	120-277V	44W	3500K	5,808	132 lm/W	50,000 hrs	>80	>0.9
			4000K	5,852	133 lm/W			
			5000K	5,896	134 lm/W			
		28W	3500K	3,892	139 lm/W			
			4000K	3,920	140 lm/W			
			5000K	3,948	141 lm/W			
		18W	3500K	2,556	142 lm/W			
			4000K	2,574	143 lm/W			
			5000K	2,592	144 lm/W			

ONE CATALOG NUMBER WITH 9 DIFFERENT OPTIONS

* Preset to highest lumen output (44W / 5000K)
 * Color Uniformity: CCT (Correlated Color Temperature) range as per guidelines outlined in ANSI C78.377-2017.

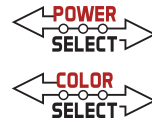

KT-MSLED44PS-4-8CSA-VDIM

LED MICROSTRIP FIXTURE

PHOTOMETRIC SPECIFICATIONS

ISOCANDELA PLOT

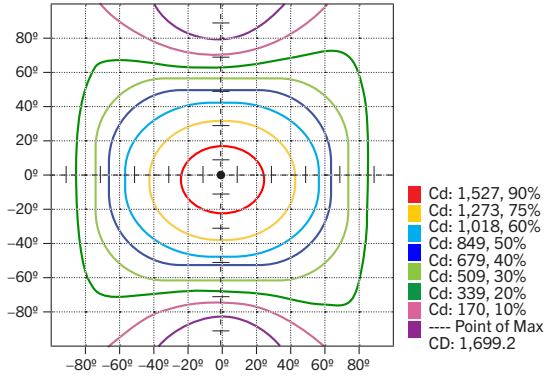

POLAR CANDELA DISTRIBUTION

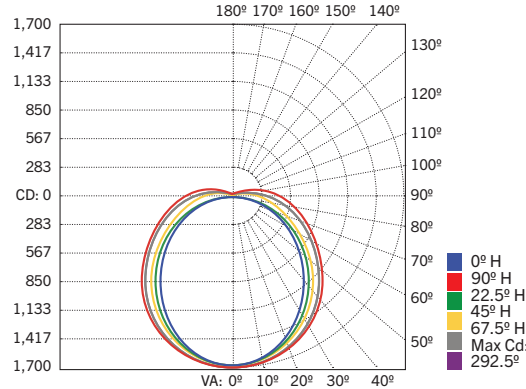

ZONAL LUMEN SUMMARY

Zone	Lumens	% Luminaire
0-30	1,295.9	21.9%
0-40	2,122.9	35.9%
0-60	3,804.3	64.3%
60-90	1,556.1	26.3%
70-100	1,110.0	18.8%
90-120	457.1	7.7%
0-90	5,360.4	90.6%
90-180	553.4	9.4%
0-180	5,913.8	100%

PHYSICAL SPECIFICATIONS

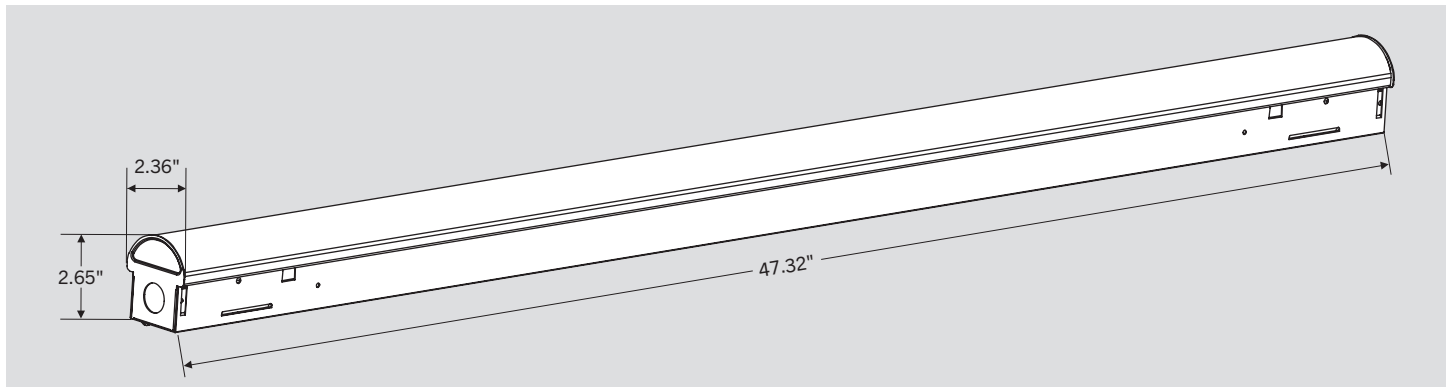

WIRING DIAGRAMS

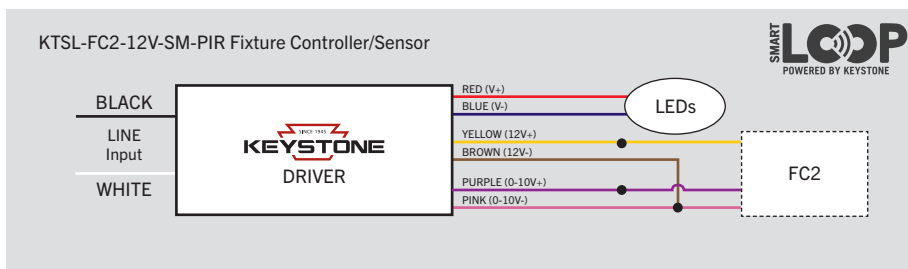
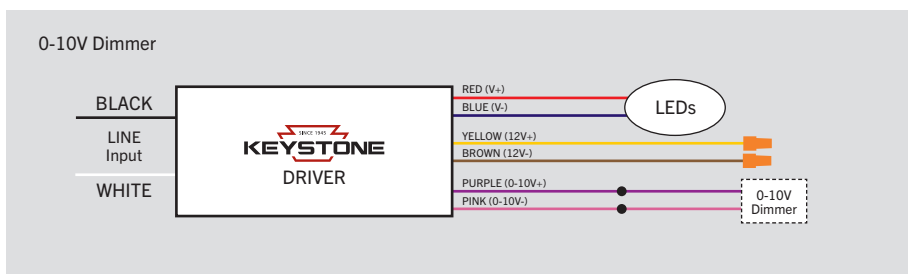

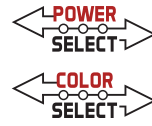

KT-MSLED44PS-4-8CSA-VDIM

LED MICROSTRIP FIXTURE

SENSORS (SOLD SEPARATELY)

ORDER CODE	DESCRIPTION
KTSL-FC2-12V-SM-PIR*	Bluetooth mesh wireless low voltage fixture controller for SmartLoop system with integrated daylight and PIR motion
KTS-MW3-UV-KO-K2	Microwave Sensor Kit, includes 120-277V input to 12V DC convector, 12V input sensor head, Nomex Sleeve, Extension Neck

*Requires KT-MSLED-SLB-1 mounting bracket



Fixture installed with KTSL-FC2-12V-SM-PIR and KT-MSLED-SLB-1 bracket

ACCESSORIES (SOLD SEPARATELY)

ORDER CODE	DESCRIPTION
KT-MSLED-LSM-KIT	Linking Surface Mount Kit for MSLED fixtures. Includes end to end metal bracket and KO grommet
KT-MSLED-VH-KIT	V-Hook and Chain Kit for Keystone Micro LED Strip fixtures. Includes (2) V-Hook and (2) chains 40in long
KT-MSLED-SLB-1	Microstrip Bracket for Smart Loop KTSL-FC2-12V-SM-PIR Sensor
KT-EMRG-LED-5C-500-SEN	LED Emergency Back-Up, 5W Constant Wattage Design, Approx 500 lumens
KT-EMRG-LED-12C-1200	LED Emergency Back-Up, 12W Constant Wattage Design, Approx 1200 lumens

ORDERING INFORMATION

Order Code	Pack Quantity	Easy Code	UPC
KT-MSLED44PS-4-8CSA-VDIM	1	EBB-39	843654134482

CATALOG NUMBER BREAKDOWN

KT-MSLED44PS-4-8CSA-VDIM

1	2	3	4	5	6	7	8	9	10																	
1 Keystone Technologies	2 LED Microstrip Fixture	3 Wattage	4 Power Select	5 4' Nominal Length	6 800 Series	7 Color Temperature	8 Color Select Designation	9 0-10V Dimming	10 Additional Options																	
						<table border="1"> <tr> <td>40</td> <td>4000K</td> </tr> <tr> <td>50</td> <td>5000K</td> </tr> <tr> <td>CS</td> <td>Color Select</td> </tr> </table>	40	4000K	50	5000K	CS	Color Select	<table border="1"> <tr> <td>A</td> <td>3500K, 4000K, 5000K</td> </tr> <tr> <td>B</td> <td>3000K, 4000K, 5000K</td> </tr> <tr> <td>C</td> <td>3000K, 3500K, 4000K, 5000K</td> </tr> </table>	A	3500K, 4000K, 5000K	B	3000K, 4000K, 5000K	C	3000K, 3500K, 4000K, 5000K	<table border="1"> <tr> <td></td> <td>No Option</td> </tr> <tr> <td>/MW</td> <td>Microwave Occupancy Sensor Installed</td> </tr> <tr> <td>/FC2-PIR</td> <td>PIR Motion Sensor</td> </tr> </table>		No Option	/MW	Microwave Occupancy Sensor Installed	/FC2-PIR	PIR Motion Sensor
40	4000K																									
50	5000K																									
CS	Color Select																									
A	3500K, 4000K, 5000K																									
B	3000K, 4000K, 5000K																									
C	3000K, 3500K, 4000K, 5000K																									
	No Option																									
/MW	Microwave Occupancy Sensor Installed																									
/FC2-PIR	PIR Motion Sensor																									