



KTLD-40-UV-SC1400-56-VDIM-W1 /USB

CONSTANT CURRENT PROGRAMMABLE LED DRIVER

DESCRIPTION

LED Driver | 40W | 120-277V Input | 470-1400mA Programmable Output Current



TOTAL POWER: 40W	OUTPUT CURRENT: 470-1400mA
INPUT VOLTAGE: 120-277Vac ±10%	DIMMING: 0-10V
INPUT FREQUENCY: 50/60 Hz	WARRANTY: 5 Years

PRODUCT FEATURES

- Built in USB-C Port for easy programing
- Meets FCC Part 15 (Class B) Consumer Limits
- Short Circuit Overload and Open Load Protection
- Dimmable with 0-10V Dimmer (Down to 1% at Max. Output Current)
- Auxiliary Power: 12Vdc; 200mA Max.
- THD: < 20%
- -20°C/-4°F to 50°C/122°F Operating Temperature
- 90°C/194°F Maximum Case Temperature
- Input Frequency: 50/60 Hz
- Programmable output current via USB-C cable and an Android device (plus Keystone app) or PC (plus Keystone software)

PROGRAMMING FEATURES

- Drive Current (10mA Increments)
- Minimum Dimming Level (1%,3%, 5%,7%, or 10%)
- Dimming Curve (Linear, Log, Inverse Log, or Square-law)
- Minimum Dimming Voltage (1V, 1.5V, or 2V)
- Maximum Dimming Voltage (7V, 8V, or 9V)
- Dim-to-off Voltage (.8V, 1V, 1.2V, or N/A)
- Thermal Foldback Temperature (75°C, 80°C, 85°C, or 90°C)

WHAT'S NEEDED?
A Smart Current Programmable LED Driver, USB-C Cable, and a computer or phone

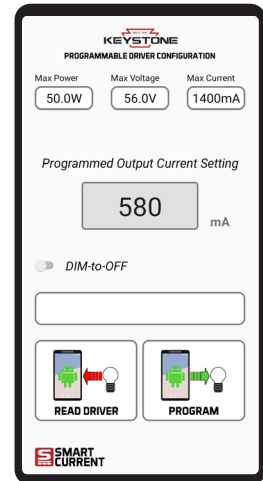

REQUIRED ACCESSORIES

Order Code	Description
KTLD-SC-USBC	USB-C to USB-C Cable

ELECTRICAL SPECIFICATIONS

Input Voltage Range	120-277Vac ±10%
Frequency	50/60 Hz
Power Factor	>0.9 under 120~277Vac Input with 80~100% Load Condition (For All Output Currents)
Inrush Current	10A @120V
Max. Input Current	0.49A @120V, 0.24A @240V and 0.22A @277V
THD	< 20% under 120~277Vac input with 80~100% load condition (For All Output Currents)
Load Regulation	± 2%
Line Regulation	± 1%
Output Tolerance	± 5% at Full Load Condition
Turn-On Delay Time	< 2 Seconds at Full Load Condition
Overshoot	< 10% at Full Load Condition
No Load Power Consumption	< 1.5W
Ripple and Noise (pk-pk)	< 3%
Withstand Voltage	Input to output, 2,800Vdc, 2mA
Leakage Current	Maximum 0.5mA at 277Vac, 60Hz input
Protection	<ul style="list-style-type: none"> • Over Voltage Protection: Hiccup mode. Protection will trigger when load voltage exceed specified output voltage and will auto recover after the fault mode is removed. • Over Current Protection: Hiccup mode. Protection will trigger when load current exceed specified output current and will auto recover after the fault mode is removed. • Short Circuit Protection: Hiccup mode. Protection will trigger when short circuit and will auto recover after the fault mode is removed. • Over Temperature Protection: Protection will trigger when driver overheat and auto-recovery when cooled down.



KTLD-40-UV-SC1400-56-VDIM-W1 /USB

CONSTANT CURRENT PROGRAMMABLE LED DRIVER

PRODUCT SPECIFICATIONS

Max. Output Power	Output Current	Output Voltage	OCV	Typical Efficiency at 120V	Typical Efficiency at 240V	Typical Efficiency at 277V	Remote Mounting Distance (#18 AWG)	Class 2	
								US	Canada
40W	470-1400mA	10-56V	60V	85% @ 1.4A, 28Vdc 86% @ 0.47A, 56Vdc	86% @ 1.4A, 28Vdc 87% @ 0.47A, 56Vdc	86% @ 1.4A, 28Vdc 87% @ 0.47A, 56Vdc	26 ft.	✓	

PHYSICAL SPECIFICATIONS

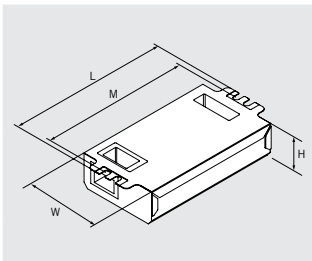

LENGTH	5.00"
WIDTH	2.38"
HEIGHT	1.00"
MOUNTING	4.62"
CASE STYLE	W1
CASE MATERIAL	Metal

WIRING SPECIFICATIONS

INPUT	Terminal Block
OUTPUT	Terminal Block
DIMMING	Terminal Block

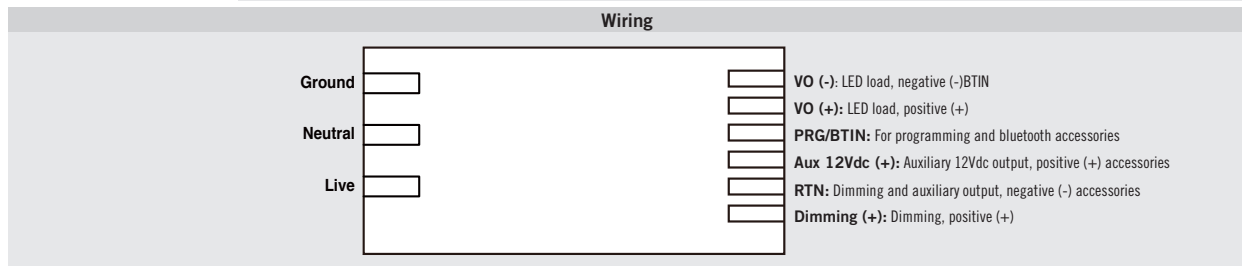
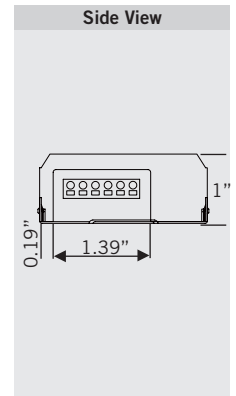
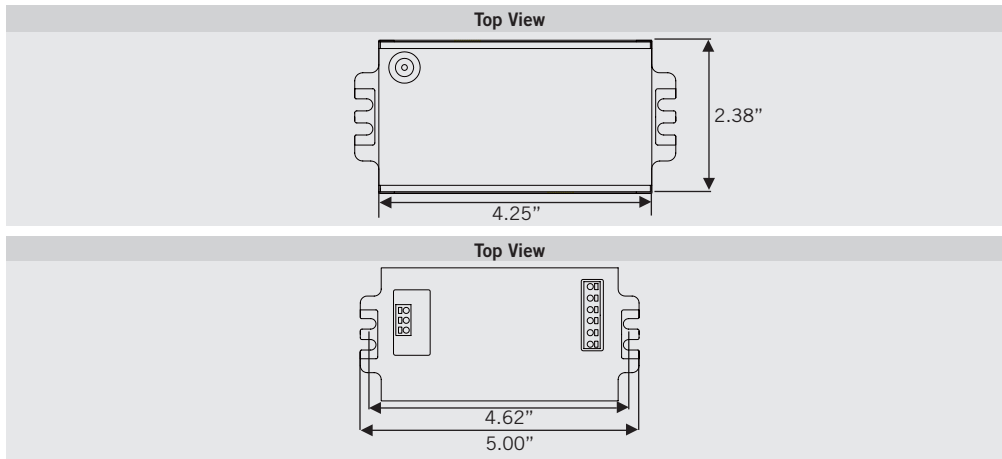
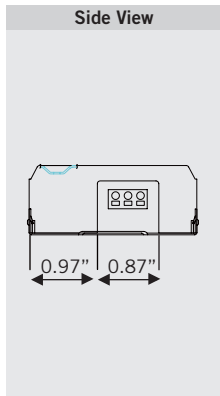

ENVIRONMENTAL SPECIFICATIONS

Operating Temperature	-20 to 50°C
Storage Temperature	-40 to 85°C
Humidity	5% to 95%
MTBF	397,500 hours at 40°C ambient (~70°C Case temp)
Life Rating	85,000 hours at 120Vac input, 100% load and 60°C case temperature
Maximum Case Temperature	90°C



KTLD-40-UV-SC1400-56-VDIM-W1 /USB

CONSTANT CURRENT PROGRAMMABLE LED DRIVER

SAFETY AND EMC COMPLIANCE

UL/cUL	UL 8750 Pending
CE	EN61347-1, EN61347-2-13
FCC, 47CFR Part 15	ANSI C63.4:2009 Class B (Consumer Limit)
EN61000-3-2	Harmonic Current Emissions Class C

LED DRIVER OUTPUT WINDOW

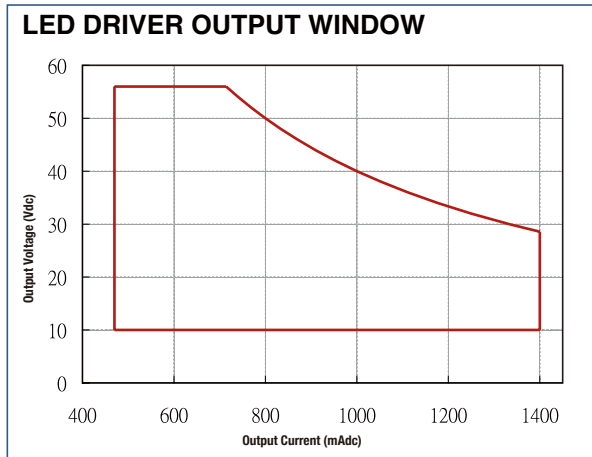

Note: Driver is in Constant Power mode from 700mA to 1400mA.

ORDERING INFORMATION

Order Code	Packaging Style	Pack Quantity	Item Status
KTLD-40-UV-SC1400-56-VDIM-W1-CP /USB	Carton Pack	50	Quick Ship

CATALOG NUMBER BREAKDOWN

KTLD-40-UV-SC1400-56-VDIM-W1-CP/USB

- 1
- 2
- 3
- 4
- 5
- 6
- 7
- 8
- 9
- 10

- 1 Keystone Technologies LED Driver
- 2 Max. Output Wattage
- 3 120–277V Input
- 4 Smart Current
- 5 Max. Output Current
- 6 Max. Output Voltage
- 7 0–10V Dimming
- 8 Case Style
- 9 Packaging Style
- 10 USB Port