



# KT-LED80HID-EX39-850-D / G2

## HID REPLACEMENT LED LAMP

### DESCRIPTION

80W HID Replacement LED Lamp | 5000K | > 80 CRI



<b>LAMP TYPE:</b> HID Replacement LED
<b>BASE TYPE:</b> EX39 (Mogul)
<b>WATTAGE:</b> 80W
<b>COLOR TEMPERATURE:</b> 5000K
<b>METAL HALIDE EQUIVALENT:</b> 320W
<b>COLOR RENDERING INDEX (CRI):</b> > 80
<b>WARRANTY:</b> 5 Years



### PRODUCT FEATURES

- Replacement for conventional metal halide lamp
- 50,000+ hour lifetime
- Environmentally friendly: no mercury used
- Instant startup
- UL Listed, DLC Listed
- Operating temperature range: -30°C to 60°C / -22°F to 140°F.
- Exceeding 30°C / 86°F in fully enclosed fixtures will engage active cooling and power de-rating to ensure full product lifetime
- Active cooling technology: When internal thermal sensor is engaged, lamp power reduces to 80% of max; when sensor cools, lamp powers back up to 100% rated power
- Integral driver, eliminates the need for external driver or ballast; includes 6kV surge protection
- IP64 Rated; integrated heat sink quickly dissipates heat and guides water intrusion out of the lamp
- Lamp includes safety tether for additional security when installing lamp in luminaire
- Suitable for use in fully enclosed fixture. Minimum lamp compartment dimensions: 9.8in x 9.8in x 10.9in
- Do not use with standard dimmers. Not compatible with phase dimmers. Dimming functions with sensors only

### OPERATING SPECIFICATIONS

#### ELECTRICAL CHARACTERISTICS

Input Voltage	Power Consumption	Power Factor	Input Current
120-277Vac	80W	>0.9	0.73A @ 120V 0.32A @ 277V

#### PHOTOMETRIC CHARACTERISTICS

Color Temperature (CCT)	5000K
Luminous Flux*	12,000 lm
Color Rendering Index (CRI)	>80
Efficacy	150 lm/W
Visible Light Area	360°

#### RATED LIFE

L70 (Hours)	50,000
-------------	--------

\* Based off of total lamp lumens

#### SPECTRAL DISTRIBUTION

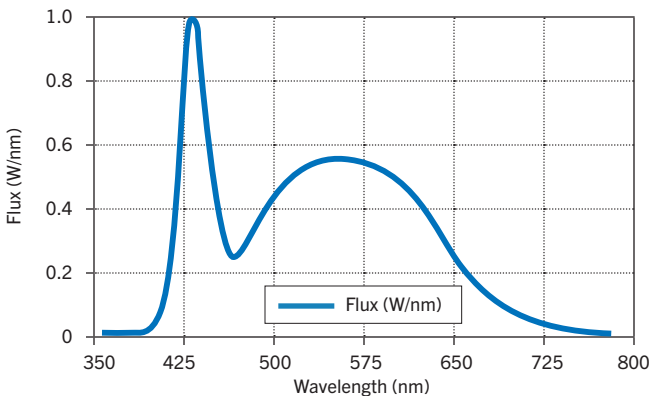

#### SMART PORT LED COMPATIBLE

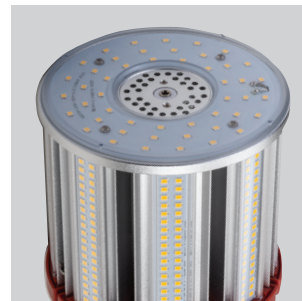

On the top of the lamp is a low-voltage AUX port for Smart Port LED sensors. See *Accessories* for available sensor options.



# KT-LED80HID-EX39-850-D /G2

## HID REPLACEMENT LED LAMP

### SMART PORT LED



On the top of the lamp is a low-voltage AUX port for lamp level sensor controls.

### SMART PORT LED AUX SENSORS

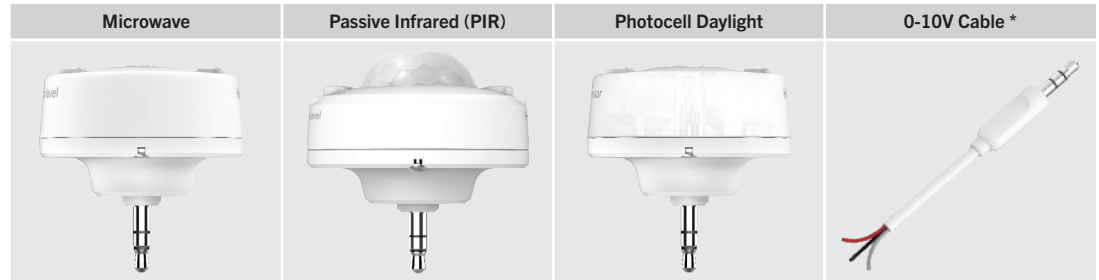

\* For use with continuous dimming applications.

### WIRING INSTRUCTIONS

#### STEP 1

**Disconnect power.** Disconnect and remove existing ballast, capacitor, and/or ignitor (where applicable) from fixture.

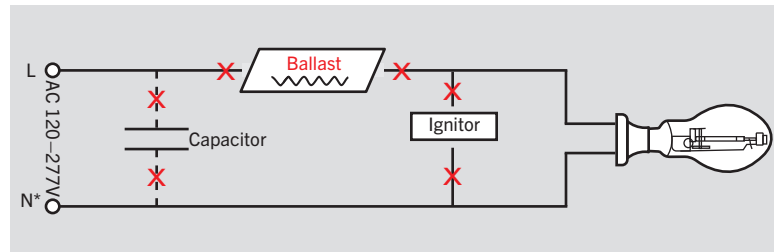

#### STEP 2

Rewire for line voltage to the lamp socket. Lamp is compatible with 120-277V from single phase, three phase wye, and three phase delta systems.

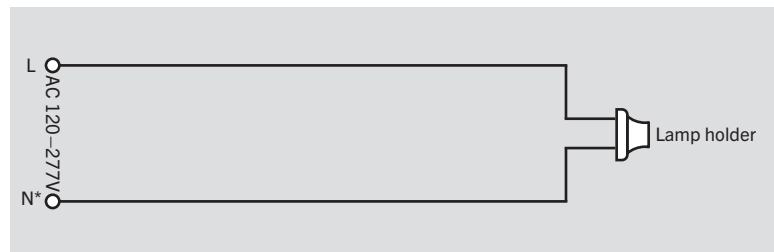

#### STEP 3

Install new LED replacement lamp. Ensure lamp is operating properly when power is turned on.

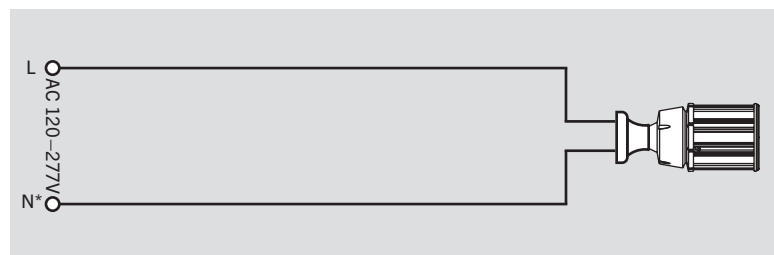
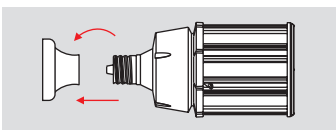

\*or other line for certain three phase systems such as 120/208 three phase wye systems

**EX39-based lamps** will work in *both* **E39** and **EX39** sockets.

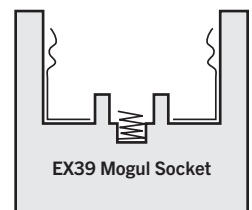
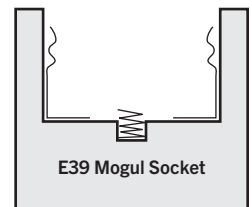



# KT-LED80HID-EX39-850-D /G2

## HID REPLACEMENT LED LAMP

### PHYSICAL CHARACTERISTICS

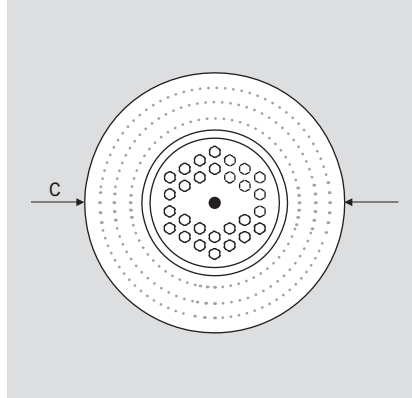
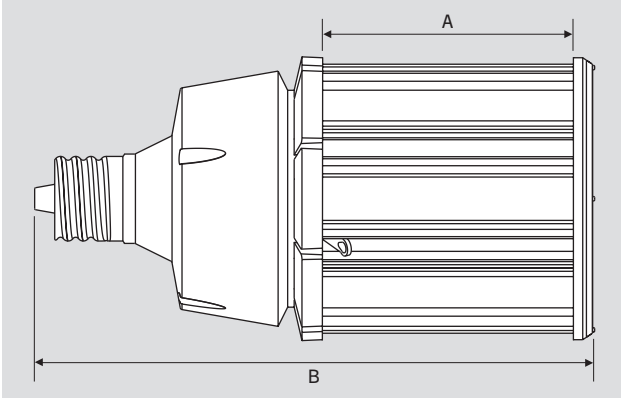

### LAMP DIMENSIONS

A (Illuminated Length)	4.00"
B (Body Length)	9.72"
C (Diameter)	5.12"

**BASE TYPE:** EX39 (Mogul)

### ACCESSORIES (SOLD SEPARATELY)

Catalog Number	Description
KTS-MW1-12V-AUX	SmartPort LED Microwave Occupancy sensor: On/Off with adjustable standby dimming level; 12V input
KTS-PIR1-12V-AUX	SmartPort LED PIR Occupancy sensor: On/Off with adjustable standby dimming level; 12V input
KTS-PS1-12V-AUX	SmartPort LED Photocell: On/Off with adjustable daylight threshold and timing; 12V input

### ORDERING INFORMATION

ORDER CODE	PACK QTY.	EASY CODE	UPC
KT-LED80HID-EX39-850-D /G2	16	XLK-40	843654121208

### CATALOG NUMBER BREAKDOWN

# KT-LED80HID-EX39-850-D /G2

1 2 3 4 5 6 7 8 9 10

- 1 Keystone Technologies
- 2 LED Lamp
- 3 Wattage
- 4 Lamp Type
- 5 Base Type
- 6 800 Series
- 7 Color Temperature
- 8 Direct-Drive Series
- 9 Second Generation
- 10 Sensor Options

### 10 Sensor Options

	No Option
/PIR	PIR Occupancy Sensor included
/MW	Microwave Occupancy Sensor included
/PS	Photocell Sensor Included