



KT-CBLEDD24-22A-8XX-VDIM-P

CENTER BASKET FIXTURE

DESCRIPTION

2' x 2' 24W LED Center Basket Fixture | 120–277V Input | 0–10V Dimming | Premium Series

APPLICATION

Used for commercial recessed ceiling applications



PRODUCT FEATURES

- Architectural grade center basket volumetric design
- Powered by Keystone 0–10V dimming LED drivers
- Smooth diffused lens for even appearance
- 0–10V dimming, 10% minimum
- Compatible with Keystone SmartSafe emergency backups
- Available with Keystone’s Smart Loop Bluetooth™ mesh wireless system, with features such as high-end trim, grouping, occupancy/vacancy sensing, and scheduling
- Ambient operating temperature: –20°C/–4°F to 50°C/122°F
- UL Listed 1598: Suitable for dry and damp locations
- THD: < 20%
- PF: > 0.95
- LED chip lifetime: L70 >100,000 hrs @ 25C°/77F° ambient fixture temp.
- Low optical flicker
- IC Rated

PRODUCT SPECIFICATIONS

Catalog Number	Color Temperature	Nominal Length	Input Voltage	Wattage	CRI	Lumen Output	Efficacy
KT-CBLEDD24-22A-835-VDIM-P	3500K	2 ft. x 2 ft.	120–277V	24W	>82.0	2,975	124 lm/W
KT-CBLEDD24-22A-840-VDIM-P	4000K	2 ft. x 2 ft.	120–277V	24W	>82.0	3,025	126 lm/W
KT-CBLEDD24-22A-850-VDIM-P	5000K	2 ft. x 2 ft.	120–277V	24W	>82.0	3,050	128 lm/W

PHOTOMETRIC SPECIFICATIONS

ISOCANDELA PLOT

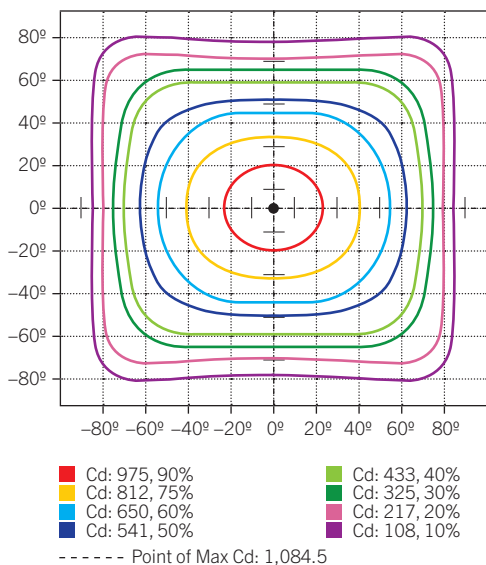

POLAR CANDELA DISTRIBUTION

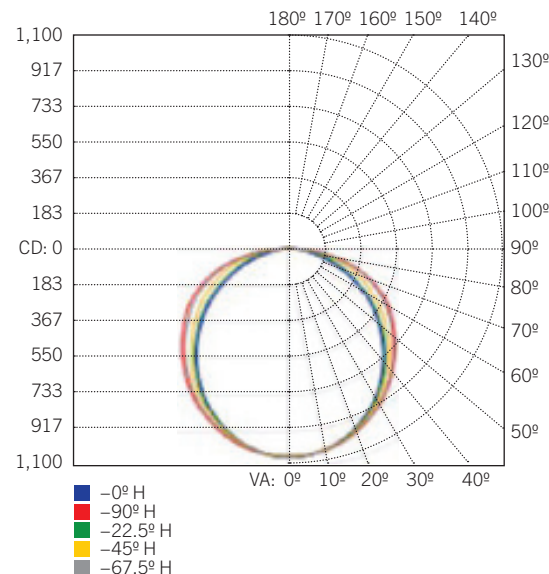

ZONAL LUMEN SUMMARY

Zone	Lumens	% Luminaire
0–30	831.4	25.7%
0–40	1359.4	42.0%
0–60	2427.4	75.0%
60–90	807.3	24.7%
0–90	3224.8	100%

KT-CBLEDD24-22A-8XX-VDIM-P

CENTER BASKET FIXTURE

PHYSICAL SPECIFICATIONS

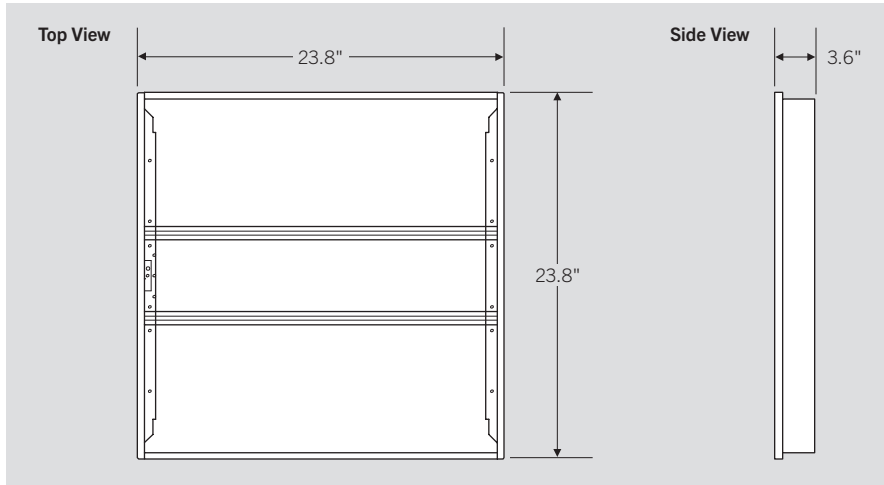

ACCESSORIES

SENSORS

Factory-Installable OR Field-Installable (field-installable purchased separately)

✓	SUFFIX*	CATALOG NUMBER	DESCRIPTION	UPC	EASY CODE
	/FC1	KTSL-FC1-UV-KO	Bluetooth mesh wireless fixture controller for SmartLoop system	843654129242	PGZ-80
	/FC1-PIR	KTSL-FC1-UV-KO-PIR	Bluetooth mesh wireless fixture controller for SmartLoop system, with remote mountable daylight and PIR motion sensor.	843654129259	MGZ-59

Keystone SmartLoop is a DLC qualified network lighting control solution, offering advanced functions such as complete wireless control, zoning, high-end trim, occupancy/vacancy sensing, scene setting, and scheduling. To learn more about smartloop, please visit <http://www.keystonetech.com/smartloop>

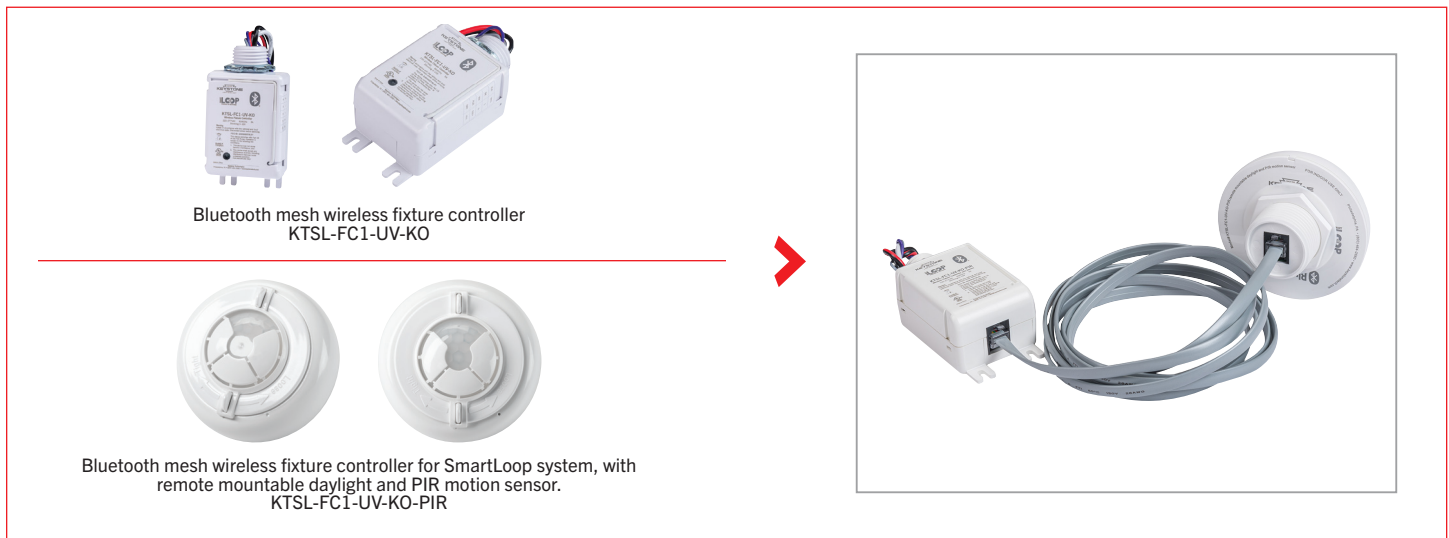

* FOR FACTORY INSTALLATION OF ACCESSORY, ADD SUFFIX TO FIXTURE PART NUMBER (SEE ORDERING EXAMPLES AND INSTRUCTIONS ON LAST PAGE OF SPEC SHEET).

(Accessories continued on next page)

KT-CBLED24-22A-8XX-VDIM-P

CENTER BASKET FIXTURE

ACCESSORIES (continued)

Field-Installable / Field-Use ONLY (purchased separately)

CATALOG NUMBER	DESCRIPTION	UPC	EASY CODE
KTSL-WS1-B-SG /G2	Bluetooth mesh wireless battery powered wall switch for SmartLoop system	843654141695	FYH-31

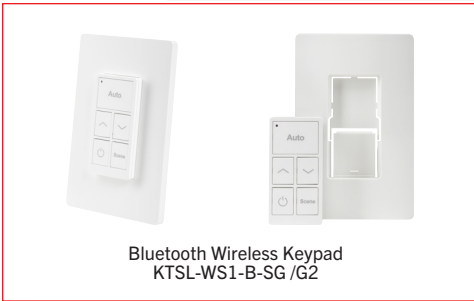

CORD SETS

Factory-Installable OR Field-Installable (field-installable purchased separately)

✓	SUFFIX*	CATALOG NUMBER	DESCRIPTION	UPC	EASY CODE
	/515P6	KT-CS-515P-6-18/3	Cord set for high bay; 125V NEMA 5-15P; straight blade plug; 6' SJTOW cable; 18/3 wire	843654140124	UKH-26
	/L715P10	KT-CS-L715P-10-16/3	Cord set for high bays; 277V NEMA L7-15P; twist lock plug; 10' SJTOW cable; 16/3 wire	843654140131	SFV-88
	/L615P10	KT-CS-L615P-10-16/3	Cord set for high bays; 250V NEMA L6-15P; twist lock plug; 10' SJTOW cable; 16/3 wire	843654140148	ZQS-05
	/L515P10	KT-CS-L515P-10-16/3	Cord set for high bays; 250V NEMA L5-15P; twist lock plug; 10' SJTOW cable; 16/3 wire	843654140155	GVH-22
	/L715P6	KT-CS-L715P-6-16/3	Cord set for high bays; 277V NEMA L7-15P; twist lock plug; 6' SJTOW cable; 16/3 wire	843654140162	DVU-44
	/L615P6	KT-CS-L615P-6-16/3	Cord set for high bays; 250V NEMA L6-15P; twist lock plug; 6' SJTOW cable; 16/3 wire	843654140179	LCW-66
	/L515P6	KT-CS-L515P-6-16/3	Cord set for high bays; 250V NEMA L5-15P; twist lock plug; 6' SJTOW cable; 16/3 wire	843654140186	POC-82
	/NP10	KT-CS-NP-10-16/3	Cord for high bays; no plug; inners 1/2" strip on both ends; 10' SJTOW cable; 16/3 wire	843654140193	YOH-90
	/NP6	KT-CS-NP-6-16/3	Cord for high bays; no plug; inners 1/2" strip on both ends; 6' SJTOW cable; 16/3 wire	843654140216	HUB-73
	/NP15	KT-CS-NP-15-16/3	Cord for high bays; no plug; inners 1/2" strip on both ends; 15' SJTOW cable; 16/3 wire	843654140209	EYD-18

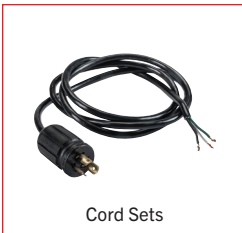

* FOR FACTORY INSTALLATION OF ACCESSORY, ADD SUFFIX TO FIXTURE PART NUMBER (SEE ORDERING EXAMPLES AND INSTRUCTIONS ON LAST PAGE OF SPEC SHEET).
NOTE: FOR CORD SETS NOT LISTED HERE, PLEASE CONTACT YOUR KEYSTONE SALES REP.

(Accessories continued on next page)

KT-CBLED24-22A-8XX-VDIM-P

CENTER BASKET FIXTURE

ACCESSORIES (continued)

EMERGENCY BACKUP

Factory-Installable OR Field-Installable (field-installable purchased separately)

✓	SUFFIX*	CATALOG NUMBER	DESCRIPTION	UPC	EASY CODE
	/EM5†	KT-EMRG-LED-5C-500	5W, 500 lumen Smart Safe emergency backup, CEC T20 Compliant	843654103099	JTR-48
	/EM12‡	KT-EMRG-LED-12C-1200	12W, 1200 lumen Smart Safe emergency backup, CEC T20 Compliant	843654103112	OJQ-32

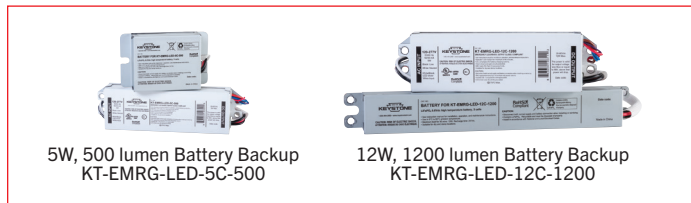

* FOR FACTORY INSTALLATION OF ACCESSORY, ADD SUFFIX TO FIXTURE PART NUMBER (SEE ORDERING EXAMPLES AND INSTRUCTIONS ON LAST PAGE OF SPEC SHEET).
† FACTORY INSTALLATION OF EMERGENCY BACKUP UNITS WILL AUTOMATICALLY INCLUDE ANY RELEVANT MOUNTING BRACKET.

MOUNTS AND BRACKETS

Field-Installable / Field-Use ONLY (purchased separately)

CATALOG NUMBER	DESCRIPTION	UPC	EASY CODE
KT-CBLED-SM-22-KIT	Surface Mount Kit for 2x2 LED Center Basket Troffers	843654127590	WVD-92
KT-CBLED-RMF-22-KIT	Recessed Mount Flange Kit for 2x2 Center Basket Fixtures	843654132969	IGR-64



STEP-DOWN TRANSFORMERS

Factory-Installable OR Field-Installable (field-installable purchased separately)

✓	SUFFIX*	CATALOG NUMBER	DESCRIPTION	UPC	EASY CODE
	/480‡	KTAT-250-480-277 /SF	Fully enclosed, single flex step-down transformer for LED high bay fixtures (250VA or lower)	843654102931	XIM-17



* FOR FACTORY INSTALLATION OF ACCESSORY, ADD SUFFIX TO FIXTURE PART NUMBER (SEE ORDERING EXAMPLES AND INSTRUCTIONS ON LAST PAGE OF SPEC SHEET).
† FACTORY INSTALLATION OF STEP-DOWN TRANSFORMER UNITS WILL AUTOMATICALLY INCLUDE ANY RELEVANT MOUNTING BRACKET.
‡ STEP-DOWN TRANSFORMERS CANNOT BE ORDERED IN CONJUNCTION WITH STANDARD SJTOW CORD SET OPTIONS (CONTACT KEYSTONE SALES REP FOR AVAILABLE CUSTOM OPTIONS IF NEEDED).



KT-CBLED24-22A-8XX-VDIM-P

CENTER BASKET FIXTURE

ORDERING INFORMATION

ORDER CODE	PACK QUANTITY	EASY CODE	UPC
KT-CBLED24-22A-835-VDIM-P	1	RPD-45	843654121932
KT-CBLED24-22A-840-VDIM-P	1	NMP-34	843654121949
KT-CBLED24-22A-850-VDIM-P	1	FYA-61	843654121956

CATALOG NUMBER BREAKDOWN

KT-CBLED24-22A-8XX-VDIM-P

- | | |
|------------------------------------|----------------------------|
| 1 Keystone Technologies | 6 80 CRI |
| 2 Center Basket LED Fixture | 7 Color Temperature |
| 3 Wattage | 8 0–10V Dimming |
| 4 2' x 2' Nominal Size | 9 Premium Series |
| 5 Lamp Type | |

ORDERING EXAMPLES

FIXTURE WITH MULTIPLE FACTORY-INSTALLED ACCESSORIES*

KT-CBLED24-22A-8XX-VDIM-P /FC1/L715P6/EM5

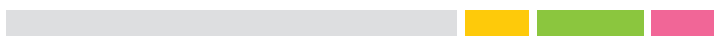

FIXTURE WITH MULTIPLE FACTORY-INSTALLED ACCESSORIES*

KT-CBLED24-22A-8XX-VDIM-P /FC1/EM5/480

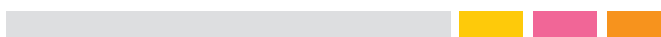

FIXTURE WITH TWO FACTORY-INSTALLED ACCESSORIES*

KT-CBLED24-22A-8XX-VDIM-P /FC1/480

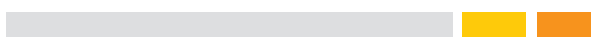

FIXTURE WITH SINGLE FACTORY-INSTALLED ACCESSORY

KT-CBLED24-22A-8XX-VDIM-P /FC1

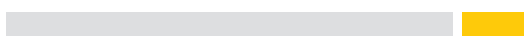

FIXTURE WITH NO FACTORY-INSTALLED ACCESSORIES

KT-CBLED24-22A-8XX-VDIM-P

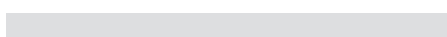

KEYSTONE FIXTURE

CATALOG NUMBER
KT-CBLED24-22A-8XX-VDIM-P

SENSORS

SUFFIX	CATALOG NUMBER
<input checked="" type="checkbox"/> /FC1	KTSL-FC1-UV-KO

CORD SETS

SUFFIX	CATALOG NUMBER
<input checked="" type="checkbox"/> /L715P6	KT-CS-L715P-6-16/3

EMERGENCY BACKUP

SUFFIX	CATALOG NUMBER
<input checked="" type="checkbox"/> /EM5	KT-EMRG-LED-5C-500

STEP-DOWN TRANSFORMERS

SUFFIX	CATALOG NUMBER
<input checked="" type="checkbox"/> /480	KTAT-250-480-277 /SF

NOTE: STEP-DOWN TRANSFORMERS CANNOT BE ORDERED IN CONJUNCTION WITH STANDARD SJTOW CORD SET OPTIONS (CONTACT KEYSTONE SALES REP FOR AVAILABLE CUSTOM OPTIONS IF NEEDED).

* WHEN ORDERING MORE THAN ONE FACTORY-INSTALLED ACCESSORY, USE MULTIPLE SUFFIXES AS SHOWN IN THE ORDERING EXAMPLES ABOVE.
 NOTE: ALL ACCESSORIES CAN ALSO BE ORDERED SEPARATELY FOR FIELD INSTALLATION USING JUST THEIR REGULAR CATALOG NUMBER, UPC, OR EASY CODE.