



KT-CWLED44PS-4-8CSA-VDIM

LED WRAP FIXTURE

DESCRIPTION

4ft LED Curved Wrap Fixture | 120-277V Input | Frosted Lens | 0-10V Dimming

APPLICATION

Used for commercial, retail, and residential applications



PRODUCT FEATURES

- Features Keystone Power Select technology (44/28/18W). Adjust power between 25/20/15W, changing lumen output to set high end trim.
- Features Keystone Color Select technology (3500/4000/5000K)
- Powered by Keystone 0–10V dimming LED drivers, dimmable to 10%
- Ambient operating temperature: –20°C/– 4°F to 45°C/113°F
- Compatible with Keystone SmartSafe emergency backups
- Available with Keystone’s Smart Loop Bluetooth™ mesh wireless system, with features such as high-end trim, grouping, occupancy/vacancy sensing, and scheduling.
- Luminaire is suitable for installation within a clothes closet storage space
- LED lifetime: L70 >100,000 hours @ 25°C ambient fixture temperature
- Low optical flicker
- THD: < 20%
- Power factor > 0.95

PERFORMANCE SPECIFICATIONS

Catalog Number	Input Voltage	Wattage	Color Temperature	Lumen Output	Efficacy	CRI	Power Factor	Lifetime
KT-CWLED44PS-4-8CSA-VDIM	120–277V	44W	3500K	5,984	136 lm/W	> 80	> 0.90	50,000hrs
			4000K	6,072	138 lm/W			
			5000K	6,116	139 lm/W			
		28W	3500K	4,004	143 lm/W			
			4000K	4,032	144 lm/W			
			5000K	4,060	145 lm/W			
		18W	3500K	2,628	146 lm/W			
			4000K	2,646	147 lm/W			
			5000K	2,664	148 lm/W			

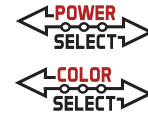

KT-CWLED44PS-4-8CSA-VDIM

LED WRAP FIXTURE

PHOTOMETRIC SPECIFICATIONS

POLAR CANDELA DISTRIBUTION

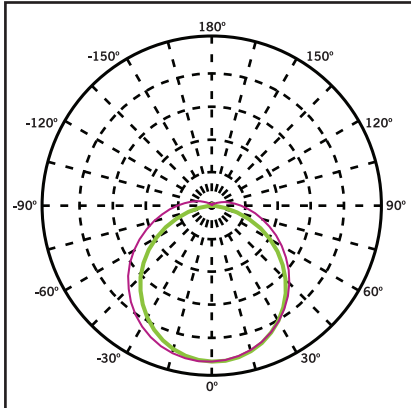

Maximum Candela = 1846.0
 Located at Horizontal Angle = 0,
 Vertical Angle 0

1. Violet Vertical Plane through Horizontal Angles (90-270)
2. Green Vertical Plane through Horizontal Angles (0-180)

Beam Angle: 220°

Visible Light Area: 325°

RELATIVE SPECTRAL POWER DISTRIBUTION

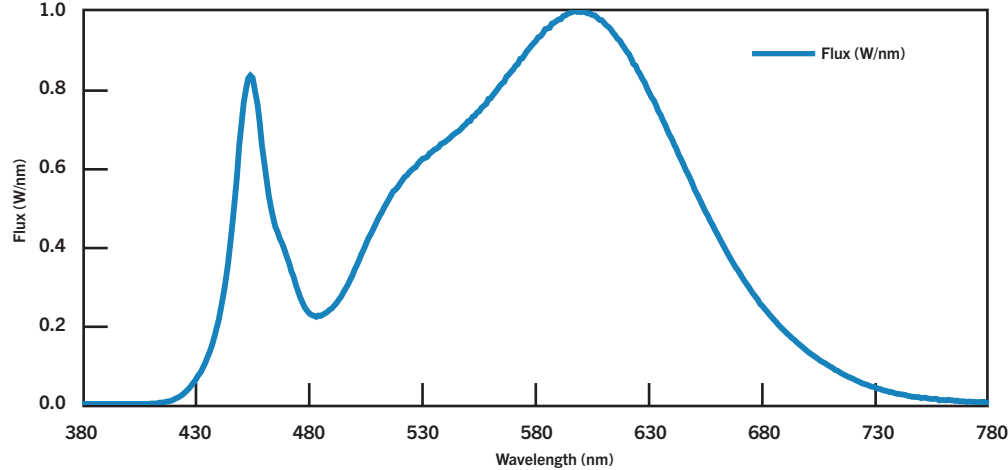

PHYSICAL SPECIFICATIONS

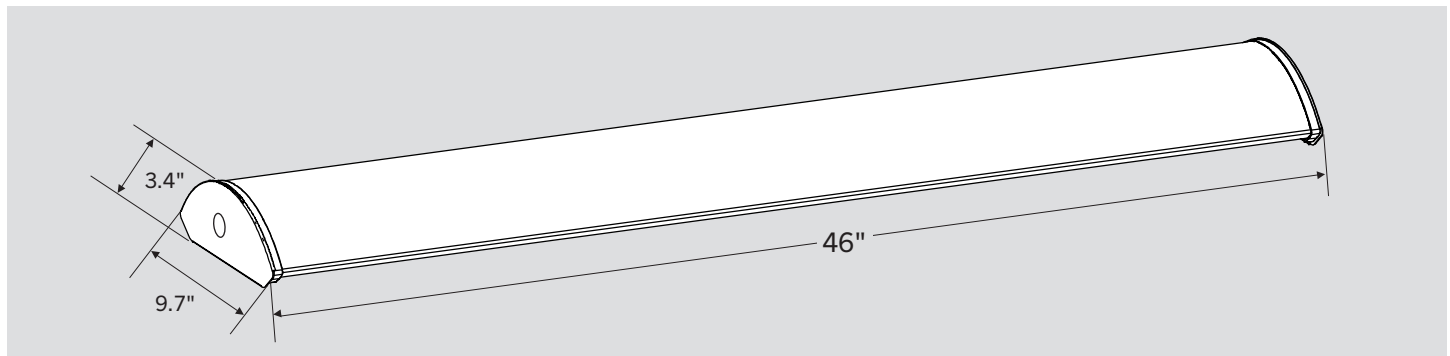

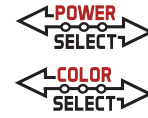

KT-CWLED44PS-4-8CSA-VDIM

LED WRAP FIXTURE

WIRING DIAGRAMS

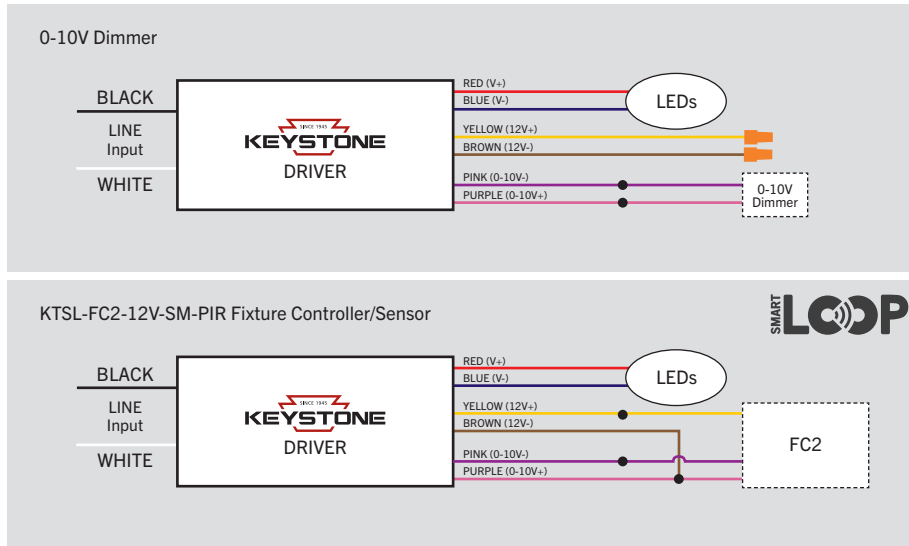

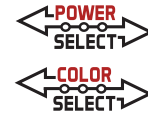

KT-CWLED44PS-4-8CSA-VDIM

LED WRAP FIXTURE

ACCESSORIES

SENSORS

Factory-Installable OR Field-Installable (field-installable purchased separately)

✓	SUFFIX*	CATALOG NUMBER	DESCRIPTION	UPC	EASY CODE
	/FC2	KTSL-FC2-12V-SM-PIR	"Bluetooth mesh wireless low voltage individual fixture controller for SmartLoop system with integrated daylight and PIR motion sensors."	843654135236	TCM-01
	/MW	KTS-MW3-UV-KO-K2	LED Microwave Occupancy/Daylight Sensor Performance Parameters Set by Remote Control	843654134352	TBV-76

Keystone SmartLoop is a DLC qualified network lighting control solution, offering advanced functions such as complete wireless control, zoning, high-end trim, occupancy/vacancy sensing, scene setting, and scheduling. To learn more about smartloop, please visit <http://www.keystonetech.com/smartloop>



CORD SETS

Factory-Installable OR Field-Installable (field-installable purchased separately)

✓	SUFFIX*	CATALOG NUMBER	DESCRIPTION	UPC	EASY CODE
	/515P6	KT-CS-515P-6-18/3	Cord set for high bay; 125V NEMA 5-15P; straight blade plug; 6' SJTOW cable; 18/3 wire	843654140124	UKH-26
	/L715P10	KT-CS-L715P-10-16/3	Cord set for high bays; 277V NEMA L7-15P; twist lock plug; 10' SJTOW cable; 16/3 wire	843654140131	SFV-88
	/L615P10	KT-CS-L615P-10-16/3	Cord set for high bays; 250V NEMA L6-15P; twist lock plug; 10' SJTOW cable; 16/3 wire	843654140148	ZQS-05
	/L515P10	KT-CS-L515P-10-16/3	Cord set for high bays; 250V NEMA L5-15P; twist lock plug; 10' SJTOW cable; 16/3 wire	843654140155	GVH-22
	/L715P6	KT-CS-L715P-6-16/3	Cord set for high bays; 277V NEMA L7-15P; twist lock plug; 6' SJTOW cable; 16/3 wire	843654140162	DVU-44
	/L615P6	KT-CS-L615P-6-16/3	Cord set for high bays; 250V NEMA L6-15P; twist lock plug; 6' SJTOW cable; 16/3 wire	843654140179	LCW-66
	/L515P6	KT-CS-L515P-6-16/3	Cord set for high bays; 250V NEMA L5-15P; twist lock plug; 6' SJTOW cable; 16/3 wire	843654140186	POC-82
	/NP10	KT-CS-NP-10-16/3	Cord for high bays; no plug; inners 1/2" strip on both ends; 10' SJTOW cable; 16/3 wire	843654140193	YOH-90
	/NP6	KT-CS-NP-6-16/3	Cord for high bays; no plug; inners 1/2" strip on both ends; 6' SJTOW cable; 16/3 wire	843654140216	HUB-73
	/NP15	KT-CS-NP-15-16/3	Cord for high bays; no plug; inners 1/2" strip on both ends; 15' SJTOW cable; 16/3 wire	843654140209	EYD-18

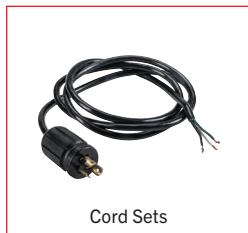

* FOR FACTORY INSTALLATION OF ACCESSORY, ADD SUFFIX TO FIXTURE PART NUMBER (SEE ORDERING EXAMPLES AND INSTRUCTIONS ON LAST PAGE OF SPEC SHEET).
NOTE: FOR CORD SETS NOT LISTED HERE, PLEASE CONTACT YOUR KEYSTONE SALES REP.

(Accessories continued on next page)



KT-CWLED44PS-4-8CSA-VDIM

LED WRAP FIXTURE

ACCESSORIES (continued)

EMERGENCY BACKUP

Factory-Installable OR Field-Installable (field-installable purchased separately)

✓	SUFFIX*	CATALOG NUMBER	DESCRIPTION	UPC	EASY CODE
	/EM5 [†]	KT-EMRG-LED-5C-500	5W, 500 lumen Smart Safe emergency backup, CEC T20 Compliant	843654103099	JTR-48
	/EM12 [†]	KT-EMRG-LED-12C-1200	12W, 1200 lumen Smart Safe emergency backup, CEC T20 Compliant	843654103112	OJQ-32

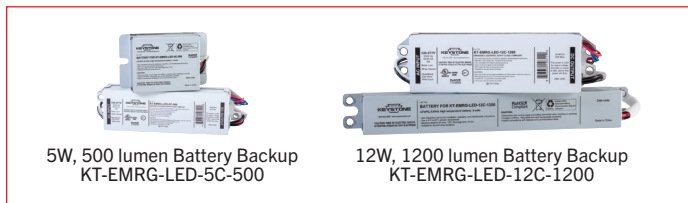

* FOR FACTORY INSTALLATION OF ACCESSORY, ADD SUFFIX TO FIXTURE PART NUMBER (SEE ORDERING EXAMPLES AND INSTRUCTIONS ON LAST PAGE OF SPEC SHEET).
[†] FACTORY INSTALLATION OF EMERGENCY BACKUP UNITS WILL AUTOMATICALLY INCLUDE ANY RELEVANT MOUNTING BRACKET.

MOUNTS AND BRACKETS

Field-Installable / Field-Use ONLY (purchased separately)

CATALOG NUMBER	DESCRIPTION	UPC	EASY CODE
KT-CWLED-SLB-1	Microstrip Bracket for Smart Loop KTSL-FC2-12V-SM-PIR Sensor	843654139876	KPV-40
KT-CWLED-TRIM-1	Trim plate for KT-CWLED fixtures. Used to cover up existing holes from larger fixtures. 20in x 52in.	843654138749	YMZ-64

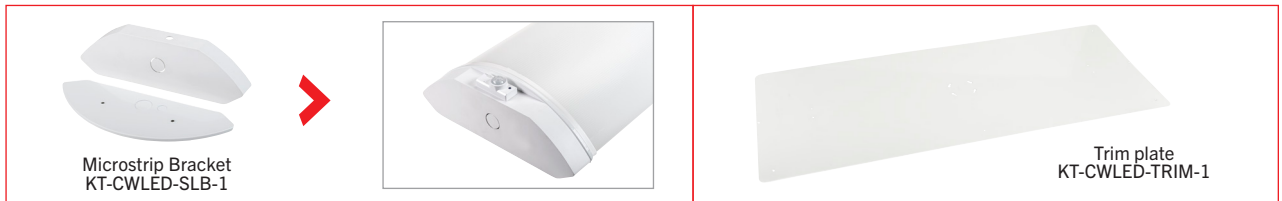

STEP-DOWN TRANSFORMERS

Factory-Installable OR Field-Installable (field-installable purchased separately)

✓	SUFFIX*	CATALOG NUMBER	DESCRIPTION	UPC	EASY CODE
	/480 [‡]	KTAT-250-480-277 /SF	Fully enclosed, single flex step-down transformer for LED high bay fixtures (250VA or lower)	843654102931	XIM-17



* FOR FACTORY INSTALLATION OF ACCESSORY, ADD SUFFIX TO FIXTURE PART NUMBER (SEE ORDERING EXAMPLES AND INSTRUCTIONS ON LAST PAGE OF SPEC SHEET).
[†] FACTORY INSTALLATION OF STEP-DOWN TRANSFORMER UNITS WILL AUTOMATICALLY INCLUDE ANY RELEVANT MOUNTING BRACKET.
[‡] STEP-DOWN TRANSFORMERS CANNOT BE ORDERED IN CONJUNCTION WITH STANDARD SJTOW CORD SET OPTIONS (CONTACT KEYSTONE SALES REP FOR AVAILABLE CUSTOM OPTIONS IF NEEDED).

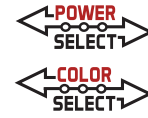

KT-CWLED44PS-4-8CSA-VDIM

LED WRAP FIXTURE

ORDERING INFORMATION

ORDER CODE	PACK QTY.	EASY CODE	UPC
KT-CWLED44PS-4-8CSA-VDIM	1	JWD-82	843654137292

CATALOG NUMBER BREAKDOWN

KT-CWLED44PS-4-8CSA-VDIM

1 2 3 4 5 6 7 8 9

- | | |
|---------------------------|----------------------------|
| 1 Keystone Technologies | 7 Color Select |
| 2 LED Curved Wrap Fixture | 8 Color Select Designation |
| 3 Wattage | 9 0-10V Dimming |
| 4 Power Select | |
| 5 4' Nominal Length | |
| 6 80 CRI | |

ORDERING EXAMPLES

FIXTURE WITH MULTIPLE FACTORY-INSTALLED ACCESSORIES*

KT-CWLED44PS-4-8CSA-VDIM /MW/L715P6/EM5

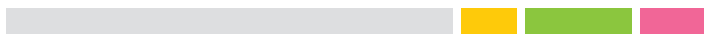

FIXTURE WITH MULTIPLE FACTORY-INSTALLED ACCESSORIES*

KT-CWLED44PS-4-8CSA-VDIM /MW/EM5/480

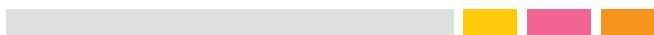

FIXTURE WITH TWO FACTORY-INSTALLED ACCESSORIES*

KT-CWLED44PS-4-8CSA-VDIM /MW/480

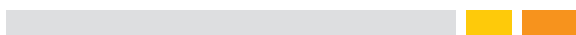

FIXTURE WITH SINGLE FACTORY-INSTALLED ACCESSORY

KT-CWLED44PS-4-8CSA-VDIM /MW

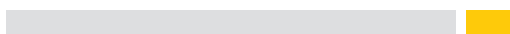

FIXTURE WITH NO FACTORY-INSTALLED ACCESSORIES

KT-CWLED44PS-4-8CSA-VDIM

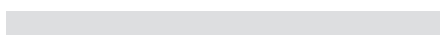

KEYSTONE FIXTURE

CATALOG NUMBER
KT-CWLED44PS-4-8CSA-VDIM

SENSORS

<input checked="" type="checkbox"/>	SUFFIX	CATALOG NUMBER
<input checked="" type="checkbox"/>	/MW	KTS-MW3-UV-KO-K2

CORD SETS

<input checked="" type="checkbox"/>	SUFFIX	CATALOG NUMBER
<input checked="" type="checkbox"/>	/L715P6	KT-CS-L715P-6-16/3

EMERGENCY BACKUP

<input checked="" type="checkbox"/>	SUFFIX	CATALOG NUMBER
<input checked="" type="checkbox"/>	/EM5	KT-EMRG-LED-5C-500

STEP-DOWN TRANSFORMERS

<input checked="" type="checkbox"/>	SUFFIX	CATALOG NUMBER
<input checked="" type="checkbox"/>	/480	KTAT-250-480-277 /SF

NOTE: STEP-DOWN TRANSFORMERS CANNOT BE ORDERED IN CONJUNCTION WITH STANDARD SJTOW CORD SET OPTIONS (CONTACT KEYSTONE SALES REP FOR AVAILABLE CUSTOM OPTIONS IF NEEDED).

* WHEN ORDERING MORE THAN ONE FACTORY-INSTALLED ACCESSORY, USE MULTIPLE SUFFIXES AS SHOWN IN THE ORDERING EXAMPLES ABOVE.
NOTE: ALL ACCESSORIES CAN ALSO BE ORDERED SEPARATELY FOR FIELD INSTALLATION USING JUST THEIR REGULAR CATALOG NUMBER, UPC, OR EASY CODE.