



KT-MSLED19-2-8XX-VDIM-P

LED MICROSTRIP FIXTURE

DESCRIPTION

2' 19W LED Microstrip Fixture | 120–277V Input | Frosted Lens | 0–10V Dimming | Premium Series

APPLICATION

Used for commercial, retail, and residential strip applications



PRODUCT FEATURES

- Powered by Keystone 0–10V dimming LED drivers
- Post-painted steel body; PMMA lens
- Smooth diffused lens for an even appearance
- 0–10V dimming, 10% minimum
- Compatible with Keystone 480–277V step down transformers
- Compatible with Keystone occupancy sensors
- Ambient operating temperature: –20°C/–4°F to 50°C/122°F
- Available with Keystone’s SmartLoop Bluetooth™ mesh wireless control system as an integral luminaire level lighting control, with features such as high-end trim, grouping, occupancy/vacancy sensing, and scheduling.
- UL Listed 1598: Suitable for dry and damp locations
- THD: < 20%
- Power factor > 0.95
- L70 > 50,000 hours

PRODUCT SPECIFICATIONS

Catalog Number	Color Temperature	Nominal Length	Input Voltage	Wattage	CRI	Lumen Output	Efficacy
KT-MSLED19-2-835-VDIM-P	3500K	2 ft.	120–277V	19W	> 82.0	2,470 lm	130 lm/W
KT-MSLED19-2-840-VDIM-P	4000K	2 ft.	120–277V	19W	> 82.0	2,489 lm	131 lm/W
KT-MSLED19-2-850-VDIM-P	5000K	2 ft.	120–277V	19W	> 82.0	2,508 lm	132 lm/W

PHOTOMETRIC SPECIFICATIONS

ISOCANDELA PLOT

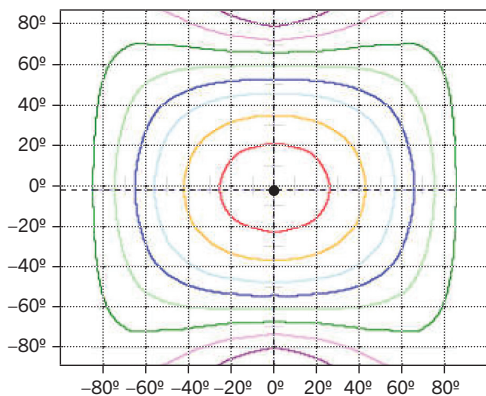

- Cd: 628, 90%
 - Cd: 523, 75%
 - Cd: 419, 60%
 - Cd: 349, 50%
 - Cd: 279, 40%
 - Cd: 209, 30%
 - Cd: 140, 20%
 - Cd: 70, 10%
- Point of Max Cd: 698.5

ZONAL LUMEN SUMMARY

Zone	Lumens	% Luminaire
0–30	539.7	22.1%
0–40	884.5	36.2%
0–60	1,588.7	65%
60–90	652.5	26.7%
70–100	459.8	18.8%
90–120	175.4	7.2%
0–90	2,241.2	91.7%
90–180	203.4	8.3%
0–180	2,444.6	100%

KT-MSLED19-2-8XX-VDIM-P
LED MICROSTRIP FIXTURE

PHYSICAL SPECIFICATIONS

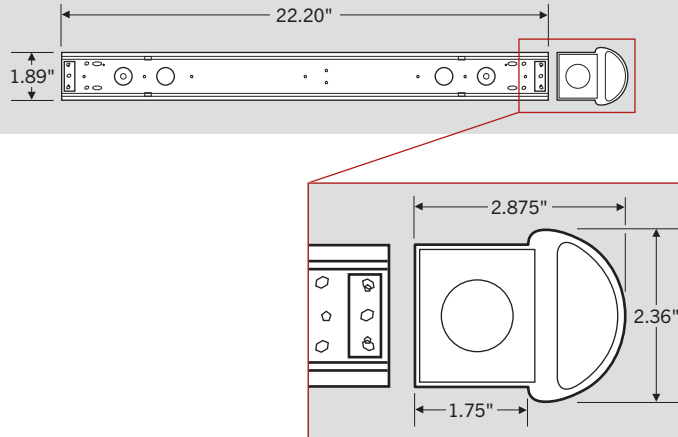

ACCESSORIES

SENSORS

Factory-Installable OR Field-Installable (field-installable purchased separately)

✓	SUFFIX*	CATALOG NUMBER	DESCRIPTION	UPC	EASY CODE
	/PIR	KTS-PIR2-UV-KO	High Bay PIR Motion Sensor, 120-347V Input. Adjustable Standby Dim level, Hold Times & Daylight Threshold controls. Fixture Mount via 1/2 inch KO	843654123288	IOF-04
	/HBFC1	KTSL-HBFC1-UV-KO-PIR	Bluetooth mesh Wireless Fixture Controller for SmartLoop System with integrated daylight and PIR motion sensor. 120-277V. 3A Max Load with 0-10V Dimming	 843654129266	AEJ-50



Smart Loop PIR Sensor
KTSL-HBFC1-UV-KO-PIR

Note: Keystone SmartLoop is a DLC Qualified Network Lighting Control solution, offering advanced functions such as complete wireless control, zoning, high-end trim, occupancy/vacancy sensing, scene setting, and scheduling. To learn more about SmartLoop, please visit <http://www.kestonetech.com/smartloop>.

* FOR FACTORY INSTALLATION OF ACCESSORY, ADD SUFFIX TO FIXTURE PART NUMBER (SEE ORDERING EXAMPLES AND INSTRUCTIONS ON LAST PAGE OF SPEC SHEET).

(Accessories continued on next page)

KT-MSLED19-2-8XX-VDIM-P

LED MICROSTRIP FIXTURE

ACCESSORIES (continued)

CORD SETS

Factory-Installable OR Field-Installable (field-installable purchased separately)

✓	SUFFIX*	CATALOG NUMBER	DESCRIPTION	UPC	EASY CODE
	/515P6	KT-CS-515P-6-18/3	Cord set; 125V NEMA 5-15P; straight blade plug ;6' SJTOW cable; 18/3 wire	843654140124	UKH-26
	/L715P10	KT-CS-L715P-10-16/3	Cord set; 277V NEMA L7-15P; twist lock plug; 10' SJTOW cable; 16/3 wire	843654140131	SFV-88
	/L615P10	KT-CS-L615P-10-16/3	Cord set; 250V NEMA L6-15P; twist lock plug; 10' SJTOW cable; 16/3 wire	843654140148	ZQS-05
	/L515P10	KT-CS-L515P-10-16/3	Cord set; 250V NEMA L5-15P; twist lock plug; 10' SJTOW cable; 16/3 wire	843654140155	GVH-22
	/L715P6	KT-CS-L715P-6-16/3	Cord set; 277V NEMA L7-15P; twist lock plug; 6' SJTOW cable; 16/3 wire	843654140162	DVU-44
	/L615P6	KT-CS-L615P-6-16/3	Cord set; 250V NEMA L6-15P; twist lock plug; 6' SJTOW cable; 16/3 wire	843654140179	LCW-66
	/L515P6	KT-CS-L515P-6-16/3	Cord set; 250V NEMA L5-15P; twist lock plug; 6' SJTOW cable; 16/3 wire	843654140186	POC-82
	/NP10	KT-CS-NP-10-16/3	Cord; no plug; inners 1/2" strip on both ends; 10' SJTOW cable; 16/3 wire	843654140193	YOH-90
	/NP6	KT-CS-NP-6-16/3	Cord; no plug; inners 1/2" strip on both ends; 6' SJTOW cable; 16/3 wire	843654140216	HUB-73
	/NP15	KT-CS-NP-15-16/3	Cord; no plug; inners 1/2" strip on both ends; 15' SJTOW cable; 16/3 wire	843654140209	EYD-18



* FOR FACTORY INSTALLATION OF ACCESSORY, ADD SUFFIX TO FIXTURE PART NUMBER (SEE ORDERING EXAMPLES AND INSTRUCTIONS ON LAST PAGE OF SPEC SHEET).
NOTE: FOR CORD SETS NOT LISTED HERE, PLEASE CONTACT YOUR KEYSTONE SALES REP.

MOUNTS AND BRACKETS

Field-Installable / Field-Use ONLY (purchased separately)

CATALOG NUMBER	DESCRIPTION	UPC	EASY CODE
KT-MSLED-VH-KIT	V-Hook and Chain Kit for Keystone Micro LED Strip fixtures. Includes (2) V-Hooks and (2) chains 40in long	843654121031	YAK-04
KT-MSLED-LSM-KIT	Linking Surface Mount Kit for MSLED fixtures. Includes End to End Metal bracket and KO grommet	843654126883	BCV-03





KT-MSLED19-2-8XX-VDIM-P

LED MICROSTRIP FIXTURE

ORDERING INFORMATION

Order Code	Pack Quantity	UPC	Easy Code
KT-MSLED19-2-835-VDIM-P	1	843654101026	RVH-24
KT-MSLED19-2-840-VDIM-P	1	843654101033	MOE-16
KT-MSLED19-2-850-VDIM-P	1	843654101040	GVO-94

CATALOG NUMBER BREAKDOWN

KT-MSLED19-2-8XX-VDIM-P

1 2 3 4 5 6 7 8

- 1 Keystone Technologies
- 2 LED Microstrip Fixture
- 3 Wattage
- 4 2' Nominal Length
- 5 80 CRI
- 6 Color Temperature
- 7 0–10V Dimming
- 8 Premium Series

ORDERING EXAMPLES

FIXTURE WITH MULTIPLE FACTORY-INSTALLED ACCESSORIES*

KT-MSLED19-2-8XX-VDIM-P /PIR /NP10 /VH

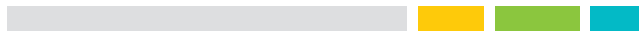

FIXTURE WITH TWO FACTORY-INSTALLED ACCESSORIES*

KT-MSLED19-2-8XX-VDIM-P /PIR /NP10

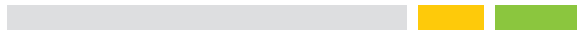

FIXTURE WITH SINGLE FACTORY-INSTALLED ACCESSORY

KT-MSLED19-2-8XX-VDIM-P /PIR

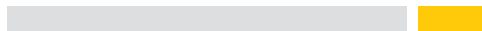

FIXTURE WITH NO FACTORY-INSTALLED ACCESSORIES

KT-MSLED19-2-8XX-VDIM-P

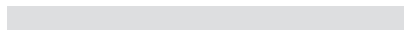

* WHEN ORDERING MORE THAN ONE FACTORY-INSTALLED ACCESSORY, USE MULTIPLE SUFFIXES AS SHOWN IN THE ORDERING EXAMPLES ABOVE.
 NOTE: ALL ACCESSORIES CAN ALSO BE ORDERED SEPARATELY FOR FIELD INSTALLATION USING JUST THEIR REGULAR CATALOG NUMBER, UPC, OR EASY CODE.

KEYSTONE FIXTURE

CATALOG NUMBER
KT-MSLED19-2-8XX-VDIM-P

SENSORS

✓ SUFFIX	CATALOG NUMBER
✓ /PIR	KTS-PIR2-UV-KO

CORD SETS

✓ SUFFIX	CATALOG NUMBER
✓ /NP10	KT-CS-NP-10-16/3

MOUNTS AND BRACKETS

✓ SUFFIX	CATALOG NUMBER
✓ /VH	KT-MSLED-VH-KIT