



# XFIT

## KT-SLFLED750-M1-XX-YM-750-VDIM

### SPORTS LIGHT FLOOD

#### DESCRIPTION

750W Sports Light Flood | 5000K | Multiple Beam Angle  
Options | 120–277V Input | Gray Housing

#### APPLICATION

High power, wide flood, pole mount illumination needs  
(municipal parks and baseball fields, high school football stadiums, driving ranges, rodeos, ski resorts, etc.)



RoHS  
Compliant

10 YEAR  
LIMITED WARRANTY



#### PRODUCT FEATURES

- Heavy duty die cast aluminum housing in gray finish offers a durable and modern aesthetic while carrying inspiration from existing legacy fixture solutions. Optimized for HID replacement needs
- Precision crafted optics that ensure uniform, proper lighting. Available in multiple beam angle options (30° standard, 20°, 40°, 60°, and 80° optional)
- Glare shield included in packaging. Easy install for use as required by site demands
- Comes with shorting cap and integrated NEMA/ANSI C136.41 7 pin twist lock receptacle
- Designed for install as a single assembly or with remote driver box. Allows for on site flexibility and lower EPA ratings
- Pre installed yoke mount bracket. Slipfitter and knuckle mounts optional (sold separately)
- Fixture mountable laser accessory available for fixture aiming, KT-SLFLED-LASER-G (sold separately)
- Ambient operating temperature:  $-40^{\circ}\text{C}/-40^{\circ}\text{F}$  to  $50^{\circ}\text{C}/122^{\circ}\text{F}$
- Powered by Keystone 0–10V dimming LED driver
- UL Certified for wet locations; IP65 rated
- Power factor:  $> 0.95$
- THD:  $< 20\%$
- LED chip lifetime: L70  $> 100,000$  hrs @  $25^{\circ}\text{C}/77^{\circ}\text{F}$  ambient fixture temperature
- Meets FCC Part 15, Part B, Class A standards for conducted and radiated emissions

#### DIMENSIONS AND WEIGHTS

Carton Dimensions	23.82"L x 24.61"W x 23.03"H
Carton Weight	57.10 lbs
Total Fixture Weight	51.81 lbs
Fixture Head Weight	37.21 lbs
Fixture Driver Box Weight	14.59 lbs

#### PRODUCT SPECIFICATIONS

Catalog Number	Wattage	CCT	Lumens	Efficacy	Input Voltage	Dimming	Beam Angle	CRI	DLC	Legacy Equivalent
KT-SLFLED750-M1-20-YM-750-VDIM	750W	5000K	105,000	140 lm/W	120–277V	0–10V	20°	$> 70$	Y	2,000W MH
KT-SLFLED750-M1-30-YM-750-VDIM							30°			
KT-SLFLED750-M1-40-YM-750-VDIM							40°			
KT-SLFLED750-M1-60-YM-750-VDIM							60°			
KT-SLFLED750-M1-80-YM-750-VDIM							80°			

Note: Fixtures with 20°, 40°, 60°, and 80° beam angles are available and assembled to order. Lead times may apply.

# KT-SLFLED750-M1-XX-YM-750-VDIM

## SPORTS LIGHT FLOOD

### PHYSICAL SPECIFICATIONS WITH DRIVER BOX ATTACHED

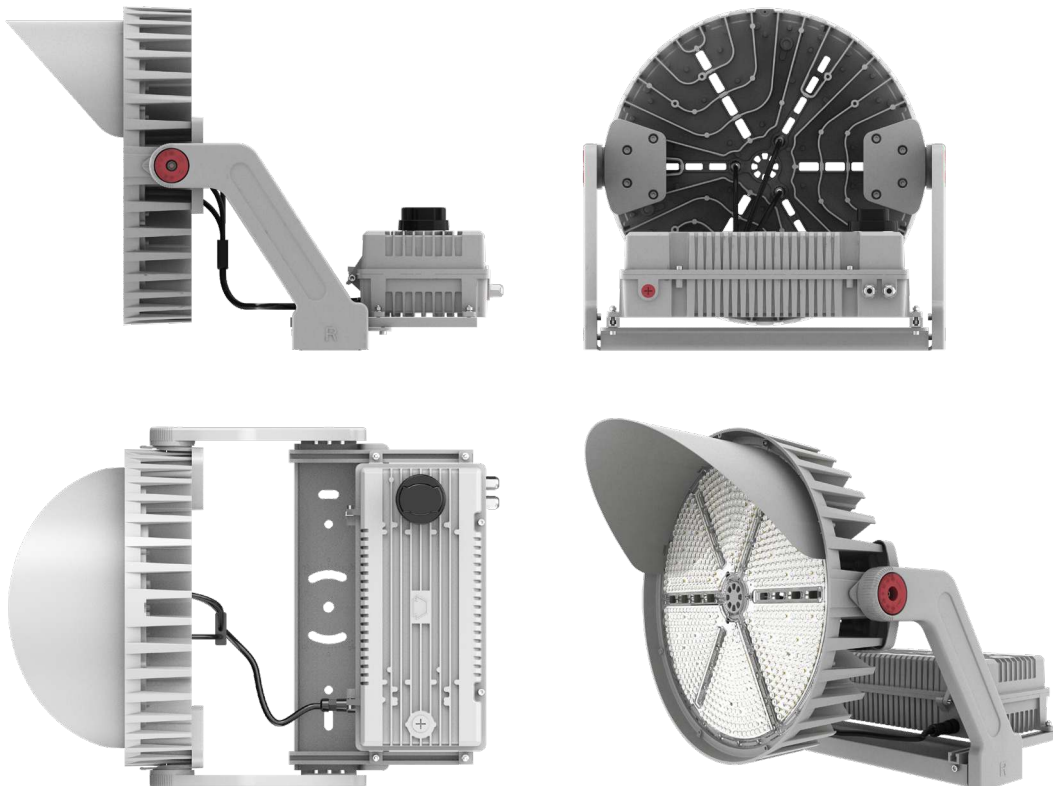
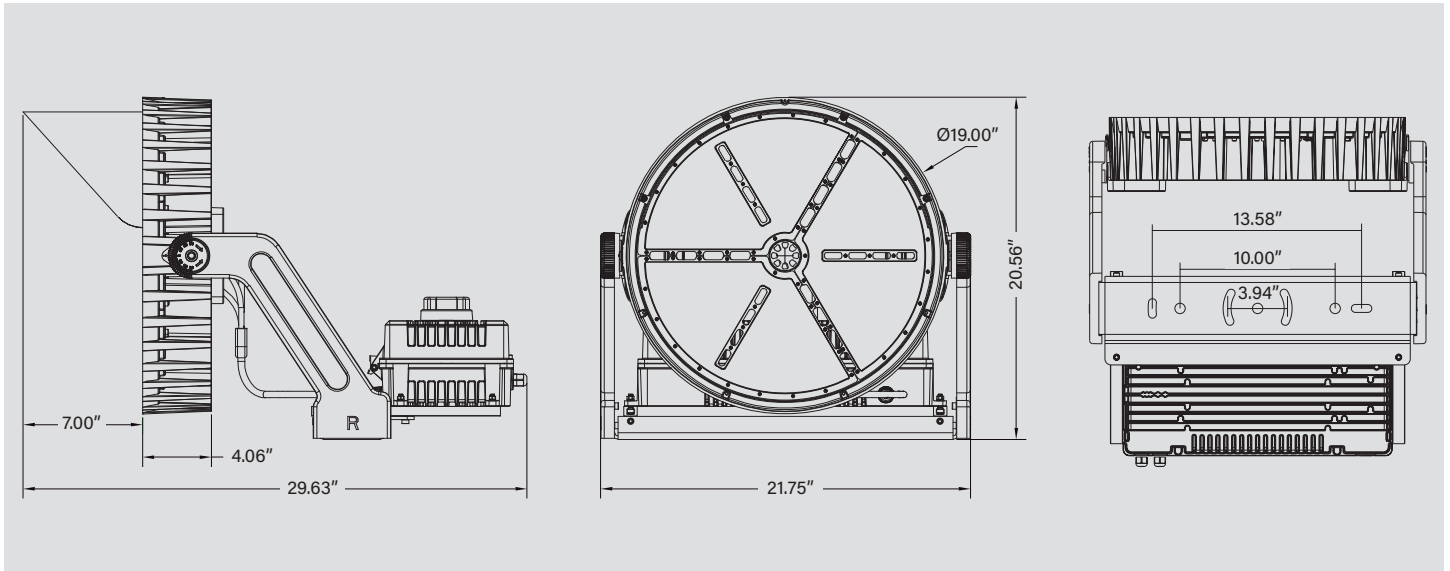

# KT-SLFLED750-M1-XX-YM-750-VDIM

## SPORTS LIGHT FLOOD

### PHYSICAL SPECIFICATIONS WITH DRIVER BOX SEPARATED

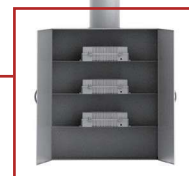
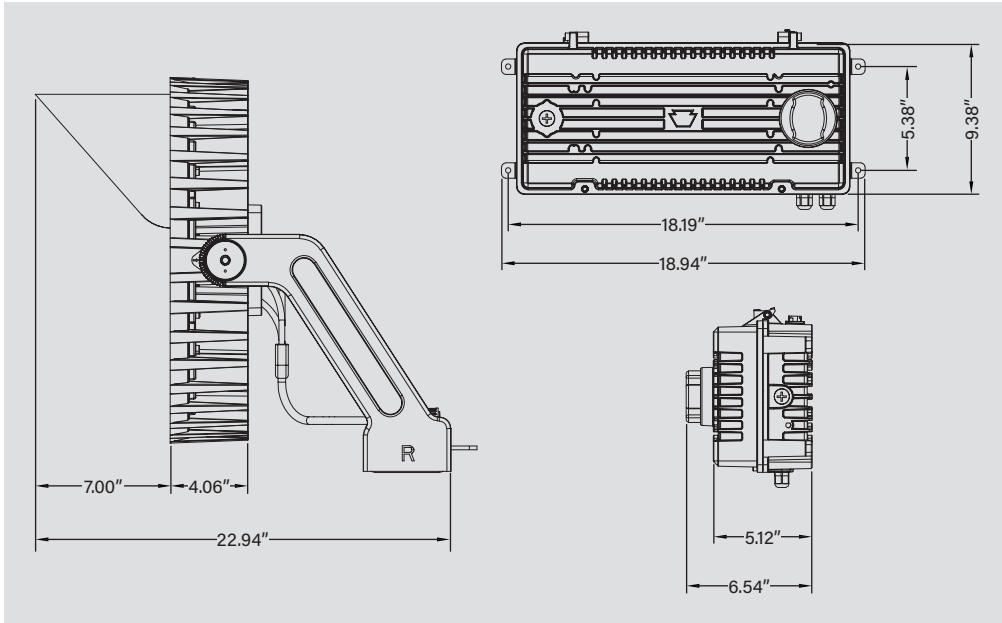

Note: Maximum cord length is 50 m / 164 ft

Note: Images are for reference only. Contact Keystone with questions regarding remote mounting and enclosures

# KT-SLFLED750-M1-XX-YM-750-VDIM

## SPORTS LIGHT FLOOD

WITH DRIVER BOX SEPARATED

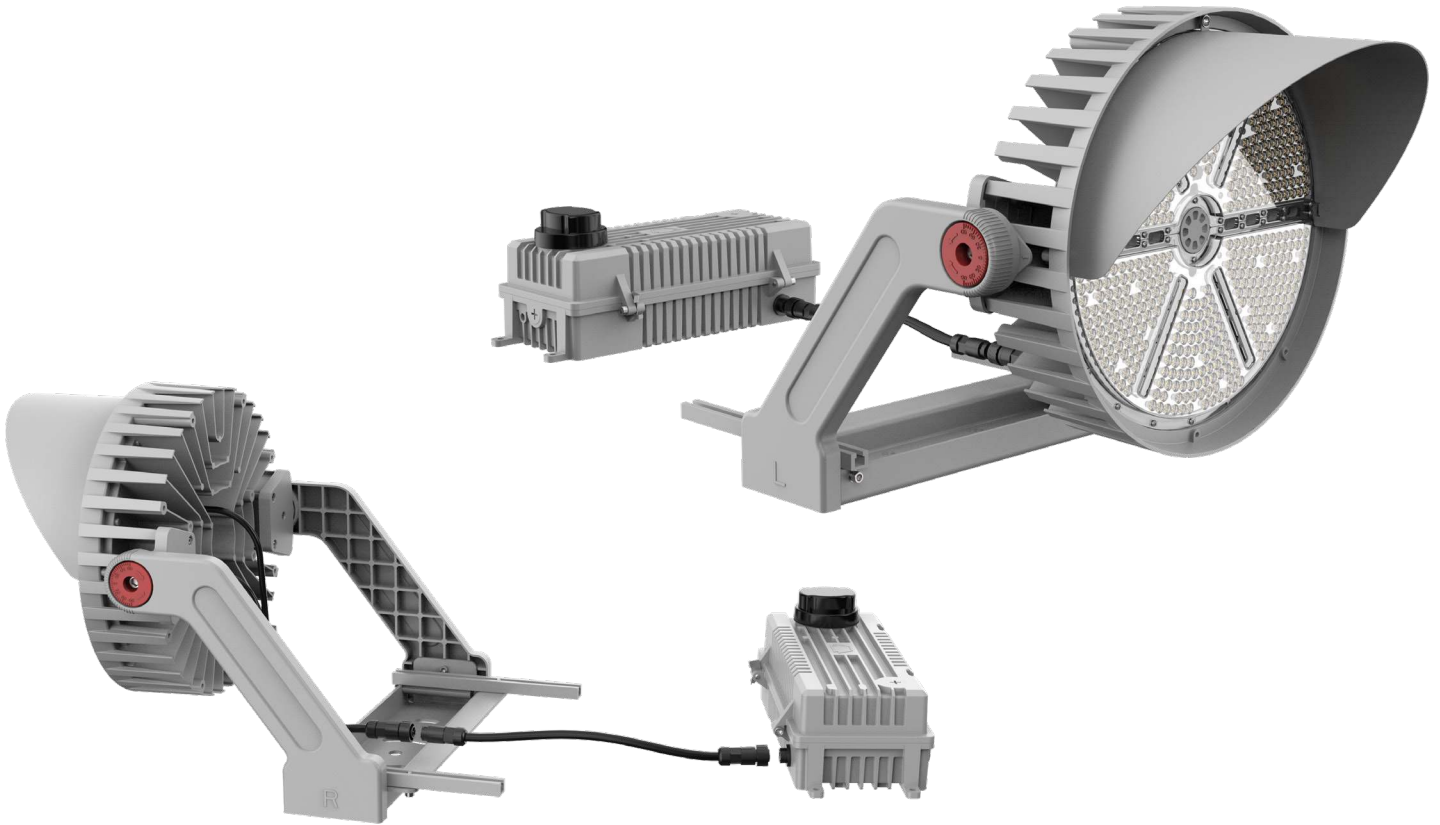

### WIRING DIAGRAM

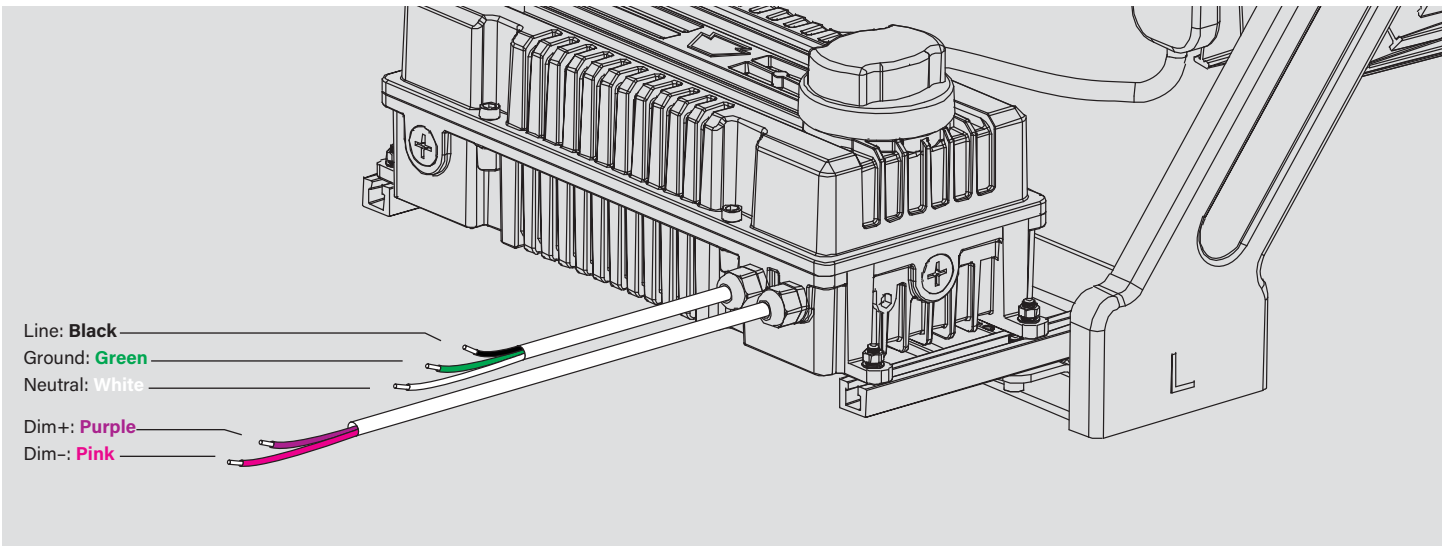

Note: 16 AWG cord. Input and dimming wires extend 3 ft from driver box.

# KT-SLFLED750-M1-XX-YM-750-VDIM

## SPORTS LIGHT FLOOD

### LIGHT DISTRIBUTION PATTERN

Photometric layouts for general reference only. All fixtures are pointed at 45° below horizontal. Each square is 10 ft x 10 ft

- 0.1 fc
- 0.2 fc
- 0.5 fc
- 1.0 fc
- 2.0 fc
- 5.0 fc
- 10.0 fc

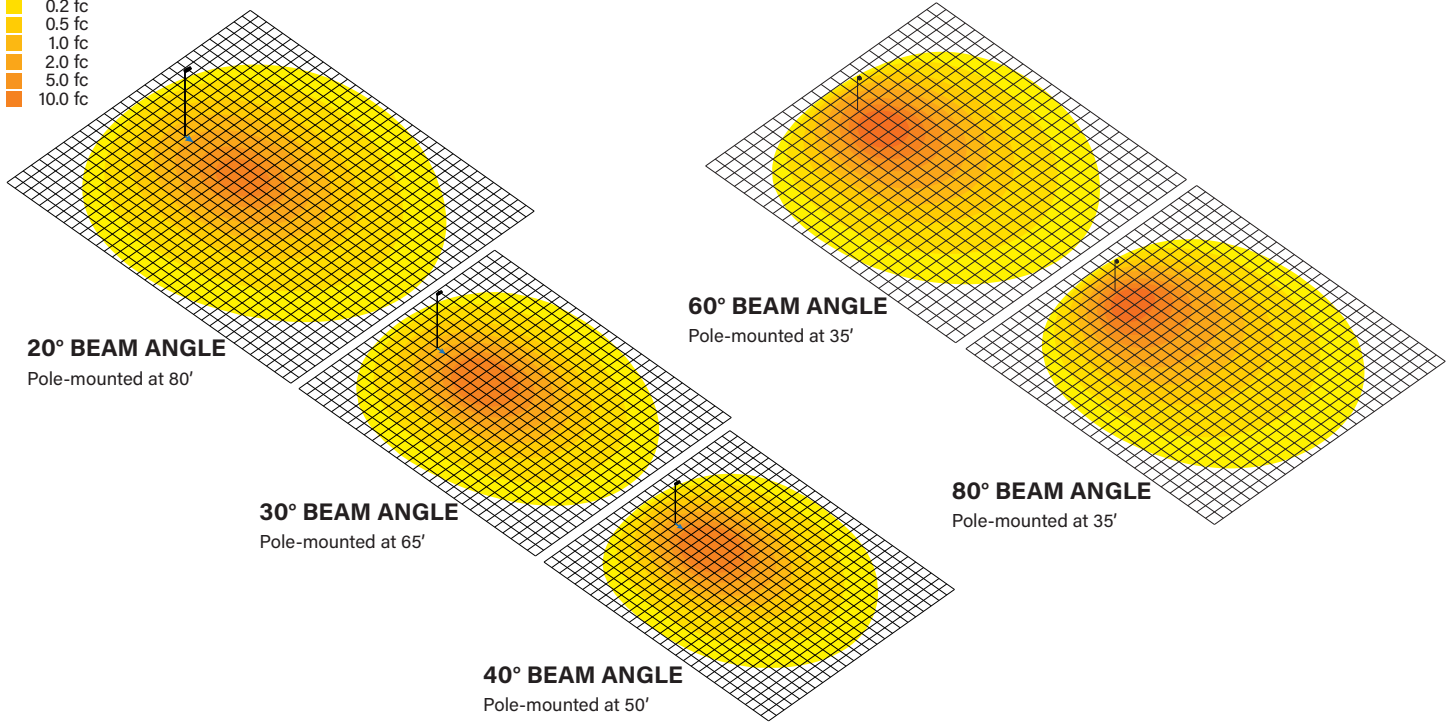

### PHOTOMETRIC SPECIFICATIONS (20° BEAM ANGLE)

#### ISOCANDELA PLOT

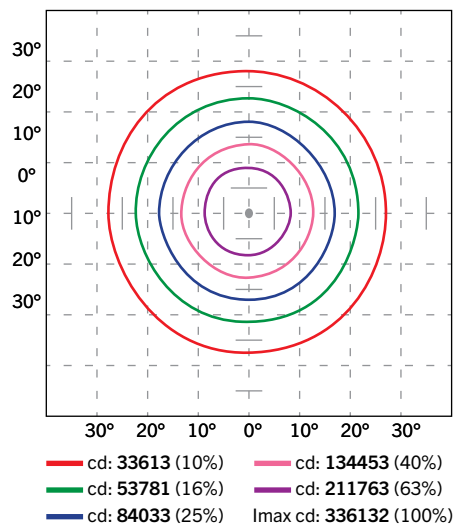

#### LUMINOUS INTENSITY DISTRIBUTION

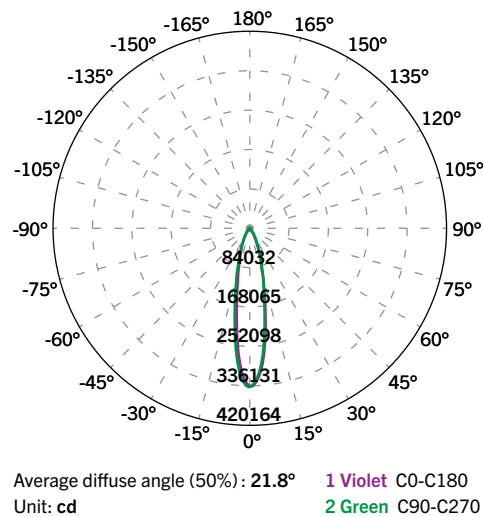

#### FLUX DISTRIBUTION

Zone	Lumens	% Luminaire
<b>Forward Light</b>	<b>53,273</b>	<b>48.6%</b>
0°-30°	35,774	32.6%
30°-60°	13,741	12.5%
60°-80°	3,458	3.2%
80°-90°	300	0.3%
<b>Back Light</b>	<b>55,074</b>	<b>50.2%</b>
0°-30°	37,316	34.0%
30°-60°	13,898	12.7%
60°-80°	3,529	3.2%
80°-90°	331	0.3%
<b>Up Light</b>	<b>1,338</b>	<b>1.2%</b>
90°-100°	89	0.1%
100°-180°	1,250	1.1%

(Photometric Specifications continued on next page)

# KT-SLFLED750-M1-XX-YM-750-VDIM

## SPORTS LIGHT FLOOD

### PHOTOMETRIC SPECIFICATIONS (30° BEAM ANGLE)

ISOCANDELA PLOT

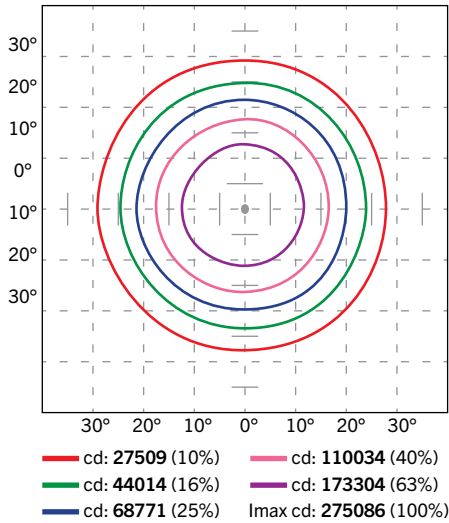

LUMINOUS INTENSITY DISTRIBUTION

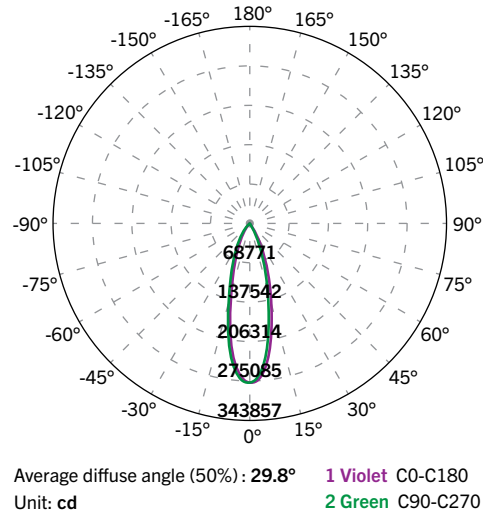

FLUX DISTRIBUTION

Zone	Lumens	% Luminaire
<b>Forward Light</b>	<b>51,813</b>	<b>48.7%</b>
0°-30°	37,800	35.5%
30°-60°	9,614	9.0%
60°-80°	3,398	3.2%
80°-90°	1,002	0.9%
<b>Back Light</b>	<b>54,668</b>	<b>51.3%</b>
0°-30°	40,317	37.9%
30°-60°	10,001	9.4%
60°-80°	3,391	3.2%
80°-90°	959	0.9%
<b>Up Light</b>	<b>0</b>	<b>0.0%</b>
90°-100°	0	0.0%
100°-180°	0	0.0%

### PHOTOMETRIC SPECIFICATIONS (40° BEAM ANGLE)

ISOCANDELA PLOT

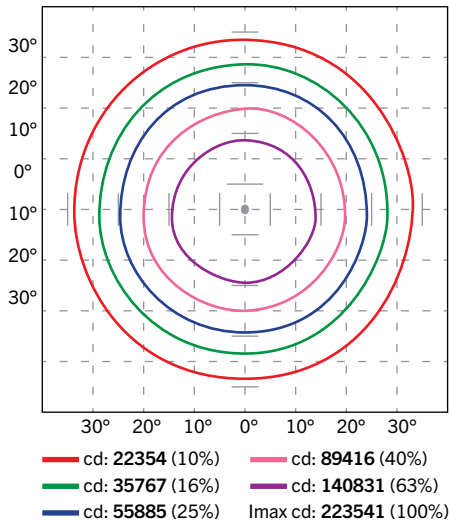

LUMINOUS INTENSITY DISTRIBUTION

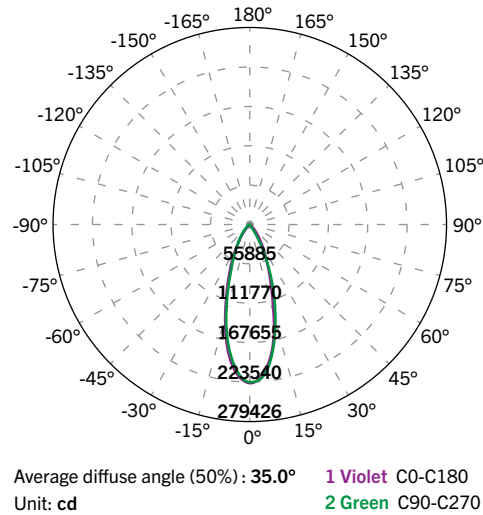

FLUX DISTRIBUTION

Zone	Lumens	% Luminaire
<b>Forward Light</b>	<b>54,679</b>	<b>49.9%</b>
0°-30°	40,336	36.8%
30°-60°	11,843	10.8%
60°-80°	2,331	2.1%
80°-90°	168	0.2%
<b>Back Light</b>	<b>53,738</b>	<b>49.0%</b>
0°-30°	39,497	36.0%
30°-60°	11,722	10.7%
60°-80°	2,332	2.1%
80°-90°	187	0.2%
<b>Up Light</b>	<b>1,259</b>	<b>1.1%</b>
90°-100°	69	0.1%
100°-180°	1,190	1.1%

# KT-SLFLED750-M1-XX-YM-750-VDIM

## SPORTS LIGHT FLOOD

### PHOTOMETRIC SPECIFICATIONS (60° BEAM ANGLE)

ISOCANDELA PLOT

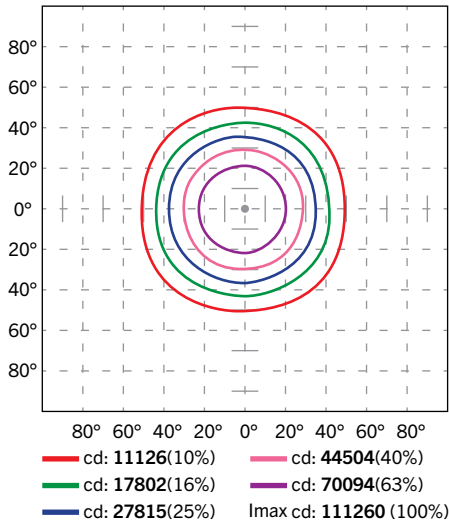

LUMINOUS INTENSITY DISTRIBUTION

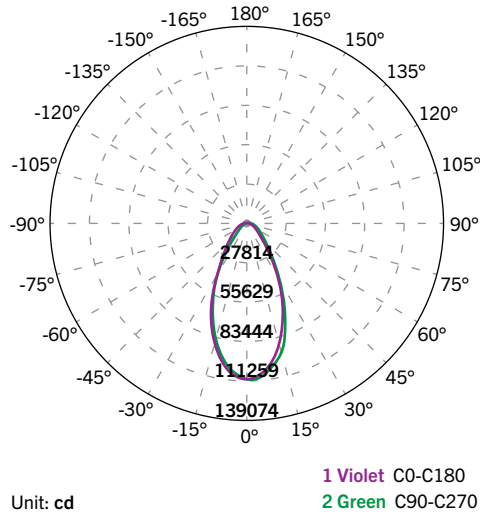

FLUX DISTRIBUTION

Zone	Lumens	% Luminaire
<b>Forward Light</b>	<b>54,721</b>	<b>50.5%</b>
0°-30°	30,891	28.2%
30°-60°	19,503	18.0%
60°-80°	4,010	3.7%
80°-90°	318	0.3%
<b>Back Light</b>	<b>53,671</b>	<b>49.5%</b>
0°-30°	30,548	28.2%
30°-60°	18,971	17.5%
60°-80°	3,871	3.6%
80°-90°	280	0.3%
<b>Up Light</b>	<b>0</b>	<b>0.0%</b>
90°-100°	0	0.0%
100°-180°	0	0.0%

### PHOTOMETRIC SPECIFICATIONS (80° BEAM ANGLE)

ISOCANDELA PLOT

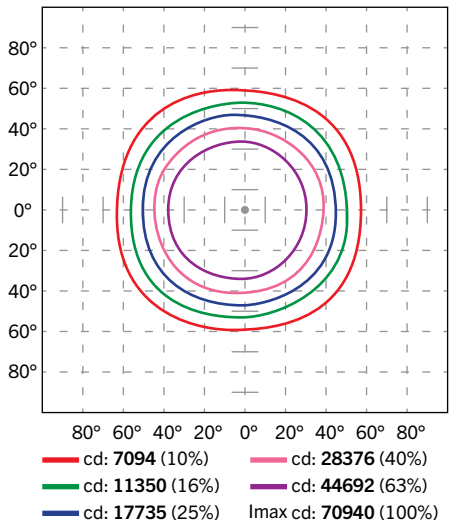

LUMINOUS INTENSITY DISTRIBUTION

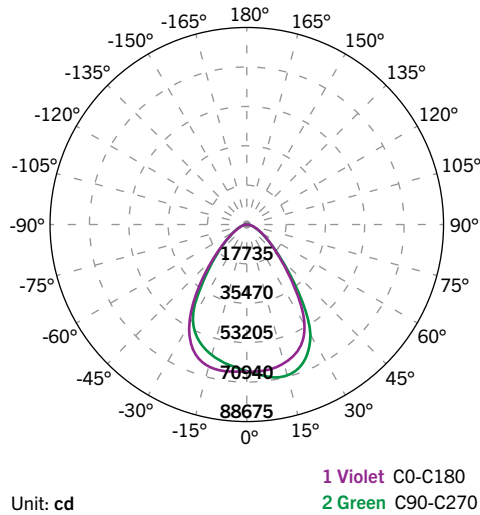

FLUX DISTRIBUTION

Zone	Lumens	% Luminaire
<b>Forward Light</b>	<b>55,063</b>	<b>50.2%</b>
0°-30°	25,859	23.6%
30°-60°	25,422	23.2%
60°-80°	3,542	3.2%
80°-90°	241	0.2%
<b>Back Light</b>	<b>54,673</b>	<b>49.8%</b>
0°-30°	26,136	23.8%
30°-60°	24,884	22.7%
60°-80°	3,435	3.1%
80°-90°	218	0.2%
<b>Up Light</b>	<b>0</b>	<b>0.0%</b>
90°-100°	0	0.0%
100°-180°	0	0.0%







# KT-SLFLED750-M1-XX-YM-750-VDIM

## SPORTS LIGHT FLOOD

### EPA SPECIFICATIONS

#### Medium-Size Fixture Housing

Conditions: Horizontal winds only for calculations. Worst case total projected area used for calculations. All drag coefficients are set as worst case 1.2. For details on exact EPA calculations and assumptions, please contact [productsupport@keystonetech.com](mailto:productsupport@keystonetech.com)

EPA Calcs (1.2*ft^2   View)			Single Fixture	2 Fixtures Side-by-Side	3 Fixtures Side-by-Side
Mounting Application	Fixture Position	Housing Size			
<b>Plate Mount</b> 	45°	M (750W)	2.63 sq. ft.	5.26 sq. ft.	7.88 sq. ft.

### ACCESSORIES

#### SENSORS

Field-Installable / Field-Use ONLY (purchased separately)

✓	CATALOG NUMBER	DESCRIPTION	COLOR	UPC	EASY CODE
	KT-TLP-UV-3PN	NEMA Type 3-Pin Photocell; 120-277V; 1800VA max	Blue	843654131825	NQT-46



#### CORD SETS

Field-Installable / Field-Use ONLY (purchased separately)

✓	CATALOG NUMBER	DESCRIPTION	UPC	EASY CODE
	KT-SLFLED-EC-35	35' extension cord to remote mount LED driver for SLFLED fixtures	843654154992	OKK-79
	KT-SLFLED-EC-65	65' extension cord to remote mount LED driver for SLFLED fixtures	843654155005	QCB-67



#### MOUNTS AND BRACKETS

Field-Installable / Field-Use ONLY (purchased separately)

✓	CATALOG NUMBER	DESCRIPTION	UPC	EASY CODE
	KT-SLFLED-KM-2-KIT	Knuckle mount kit for Series 1 Sports Light Flood, Medium Housing. Gray	843654155838	IWC-30
	KT-SLFLED-SF-M1-KIT	Slipfitter mount kit for Series 1 Sports Light Flood, Medium Housing. Fits 2 3/8" tenon. Gray	843654154930	JWV-40



Field-Installable / Field-Use ONLY (purchased separately)

✓	CATALOG NUMBER	DESCRIPTION	UPC	EASY CODE
	KT-SLFLED-LASER-G	Green laser pointer for Sports Light Flood aiming. Includes hardware to mount to SLFLED fixtures	843654155012	ESD-34



Note: Each above item has a corresponding specification sheet with technical drawings. Please visit [keystonetech.com](http://keystonetech.com) for details





# KT-SLFLED750-M1-XX-YM-750-VDIM

## SPORTS LIGHT FLOOD

### ORDERING INFORMATION

CATALOG NUMBER	UPC	EASY CODE
KT-SLFLED750-M1-20-YM-750-VDIM	843654155289	AHI-09
KT-SLFLED750-M1-30-YM-750-VDIM	843654154909	ULT-90
KT-SLFLED750-M1-40-YM-750-VDIM	843654155296	ZPD-50
KT-SLFLED750-M1-60-YM-750-VDIM	843654159850	TPR-38
KT-SLFLED750-M1-80-YM-750-VDIM	843654159867	WUM-62

### CATALOG NUMBER BREAKDOWN

# KT-SLFLED750-M1-XX-YM-750-VDIM

1	2	3	4	5	6	7	8	9	10	11
<b>1 Keystone Technologies</b>	<b>2 Fixture Type</b>	<b>3 LED Lamp</b>	<b>4 Wattage</b>	<b>5 Size</b>	<b>6 Style</b>	<b>7 Beam Angle</b>	<b>8 Mounting Options</b>	<b>9 CRI</b>	<b>10 CCT</b>	<b>11 Dimming</b>
	SLF Sports Light Flood			M Medium		20 20°	YM Yoke Mount	7 > 70	50 5000K	VDIM 0-10V
						30 30°				
						40 40°				
						60 60°				
						80 80°				