



KTLD-85-UV-SC2600-56-VDIM-U4

CONSTANT CURRENT PROGRAMMABLE LED DRIVER

DESCRIPTION

LED Driver | 85W | 120–277V Input | 860–2600mA Programmable Output Current



Class P



RoHS Compliant



10 YEAR
LIMITED WARRANTY

TOTAL POWER: 85W	OUTPUT CURRENT: 860–2600mA
INPUT VOLTAGE: 120–277Vac ±10%	DIMMING: 0–10V
INPUT FREQUENCY: 50/60 Hz	WARRANTY: 5 Years



PRODUCT FEATURES

- Meets FCC Part 15 (Class B) consumer limits
- Short circuit overload and open load protection
- Dimmable with 0–10V dimmer (down to 1% at max. output current)
- THD: < 20%
- Auxiliary Power: 12Vdc; 200mA max.
- -40°C/-40°F to 50°C/122°F operating temperature
- 90°C/194°F maximum case temperature
- Input frequency: 50/60 Hz
- Programmable output current via Keystone supplied programming jig
- Class A Sound Rating

PROGRAMMING FEATURES

- Drive current (10mA increments)
- Minimum dimming level (1%, 3%, 5%, 7%, or 10%)
- Dimming curve (linear, log, inverse log, or square-law)
- Minimum dimming voltage (1V, 1.5V, or 2V)
- Maximum dimming voltage (7V, 8V, or 9V)
- Dim-to-off voltage (0.8V, 1V, 1.2V, or N/A)
- Thermal foldback temperature (75°C/167°F, 80°C/176°F, 85°C/185°F, or 90°C/194°F)

WHAT'S NEEDED?

A SmartCurrent Programmable LED Driver, the SmartCurrent Cradle, and a computer.



ELECTRICAL SPECIFICATIONS

Input Voltage Range	120–277Vac ±10%
Frequency	50/60 Hz
Power Factor	>0.9 under 120~277Vac Input with 80~100% load condition (for all output currents)
Inrush Current	80A @277V
Max. Input Current	0.89A @120V, 0.44A @240V, and 0.38A @277V
THD	<20% under 120~277Vac input with 80~100% load condition (for all output currents)
Load Regulation	± 2%
Line Regulation	± 1%
Output Tolerance	± 5% at full load condition
Turn-On Delay Time	<0.75 seconds at full load condition
Overshoot	<10% at full load condition
No Load Power Consumption	<2W
Ripple and Noise (pk-pk)	<3%
Withstand Voltage	Input to output, 2,800Vdc, 2mA
Leakage Current	Maximum 0.5mA at 277Vac, 60Hz input
Protection	<ul style="list-style-type: none"> • Over Voltage Protection: Hiccup mode. Protection will trigger when load voltage exceeds specified output voltage and will auto recover after the fault mode is removed. • Over Current Protection: Hiccup mode. Protection will trigger when load current exceeds specified output current and will auto recover after the fault mode is removed. • Short Circuit Protection: Hiccup mode. Protection will trigger when short circuit and will auto recover after the fault mode is removed. • Over Temperature Protection: Protection will trigger when driver overheats and auto-recovery when cooled down.



KTLD-85-UV-SC2600-56-VDIM-U4

CONSTANT CURRENT PROGRAMMABLE LED DRIVER

PRODUCT SPECIFICATIONS

Max. Output Power	Output Current	Output Voltage	OCV	Typical Efficiency at 120V	Typical Efficiency at 240V	Typical Efficiency at 277V	Remote Mounting Distance (#18 AWG)	Class 2	
								US	Canada
85W	860-2600mA	10-56V	60V	85%@ 2.6A, 33Vdc 87%@ 0.86A, 56Vdc	87%@ 2.6A, 33Vdc 87%@ 0.86A, 56Vdc	87%@ 2.6A, 33Vdc 87%@ 0.86A, 56Vdc	24 ft.	✓	

PHYSICAL SPECIFICATIONS

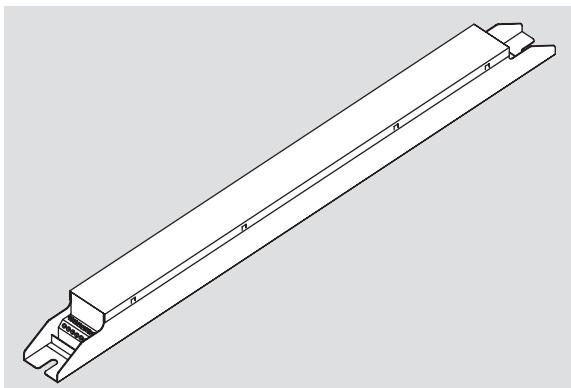

LENGTH	16.89"	MOUNTING	16.02"
WIDTH	1.18"	CASE STYLE	U4
HEIGHT	1.00"	CASE MATERIAL	Metal

TOP VIEW

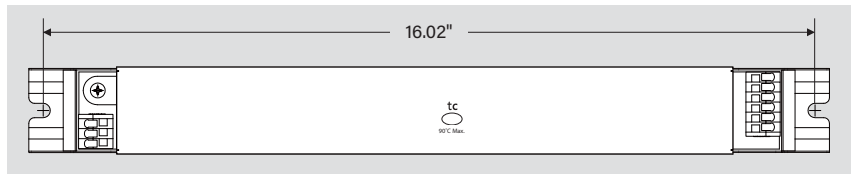

FRONT VIEW

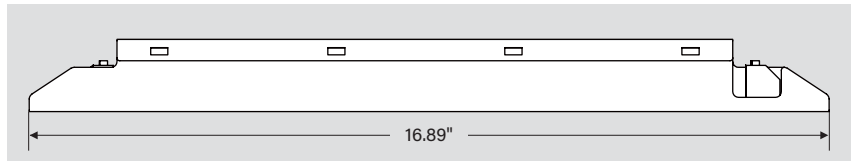

SIDE VIEW

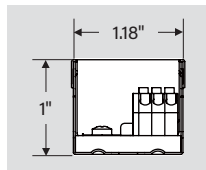

WIRING SPECIFICATIONS

INPUT	Terminal Block
OUTPUT	Terminal Block
DIMMING	Terminal Block

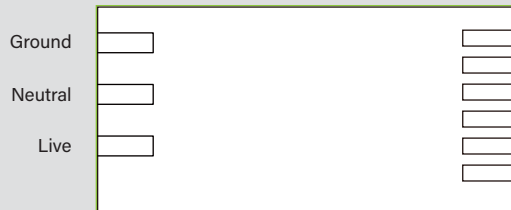

- VO (-):** LED load, negative (-) BTIN
- VO (+):** LED load, positive (+)
- PRG/BTIN:** For programming and bluetooth accessories
- Aux 12Vdc (+):** Auxiliary 12Vdc output, positive (+) accessories
- RTN:** Dimming and auxiliary output, negative (-) accessories
- Dimming (+):** Dimming, positive (+)



KTLD-85-UV-SC2600-56-VDIM-U4

CONSTANT CURRENT PROGRAMMABLE LED DRIVER

ENVIRONMENTAL SPECIFICATIONS

Operating Temperature	-40°C/-4°F to 50°C/122°F
Storage Temperature	-40°C/-40°F to 85°C/185°F
Humidity	5% to 95%
MTBF	209,100 hours at 40°C/104°F ambient (~70°C/~94°F case temperature)
Life Rating	85,000 hours at 120Vac input, 100% load and 60°C/140°F case temperature
Maximum Case Temperature	90°C/194°F
Maximum Case Temperature (tc) for 5-Year Warranty	75°C/167°F

SAFETY AND EMC COMPLIANCE

UL/cUL	UL 8750, Class P, Type HL, UL1310 Class
CE	EN61347-1, EN61347-2-13
FCC, 47CFR Part 15	ANSI C63.4:2009 Class B (consumer limit)
EN61000-3-2	Harmonic Current Emissions Class C

LED DRIVER OUTPUT WINDOW

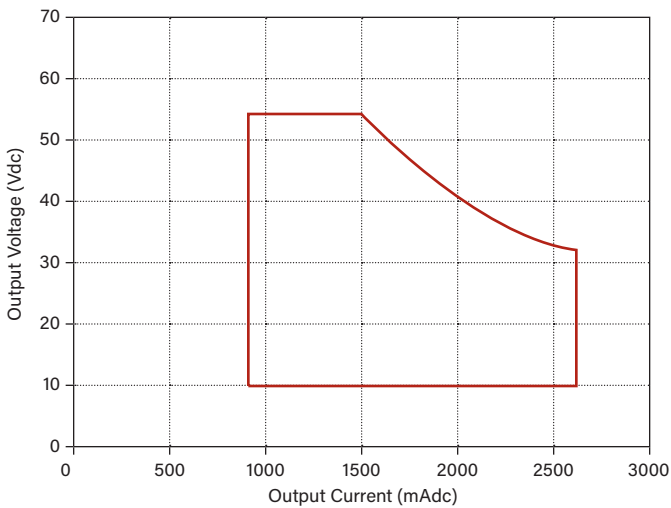

Note: driver is in constant power mode from 1500mA to 2600mA.

LIFETIME VS CASE TEMPERATURE

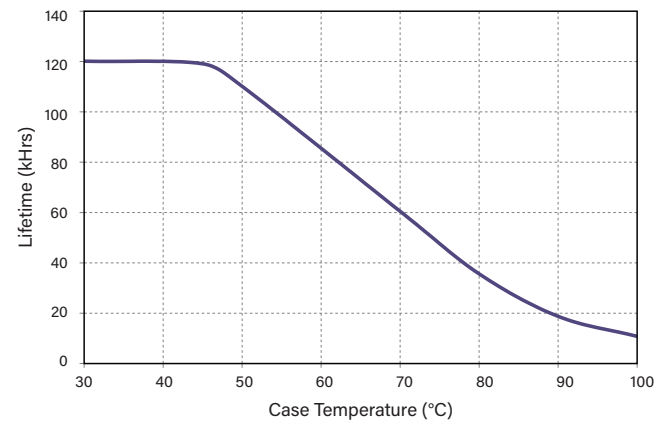

ORDERING INFORMATION

ORDER CODE	PACKAGING STYLE	PACK QUANTITY	ITEM STATUS
KTLD-85-UV-SC2600-56-VDIM-U4-CP	Carton Pack	TBD	Quick Ship

CATALOG NUMBER BREAKDOWN

KTLD-85-UV-SC2600-56-VDIM-U4-CP

1

2

3

4

5

6

7

8

9

- 1 Keystone Technologies LED Driver
- 2 Max. Output Wattage
- 3 120-277V Input
- 4 Smart Current
- 5 Max. Output Current
- 6 Max. Output Voltage
- 7 0-10V Dimming
- 8 Case Style
- 9 Packaging Style